

International Society for Soil Mechanics and
Geotechnical Engineering (ISSMGE)

The Flat Dilatometer Test (DMT) in Soil Investigations

Report of the ISSMGE
Technical Committee 16
on
Ground Property Characterisation from In-situ Testing

2001

The Flat Dilatometer Test (DMT) in soil investigations

A Report by the ISSMGE Committee TC16

Marchetti S., Monaco P., Totani G. & Calabrese M.
University of L'Aquila, Italy

TC16 DMT Report (2001). "The Flat Dilatometer Test (DMT) in Soil Investigations". *A Report by the ISSMGE Committee TC16*. 41 pp. Reprinted in Proc. DMT 2006, Washington D.C.

ABSTRACT: This report presents an overview of the DMT equipment, testing procedure, interpretation and design applications. It is a statement on the general practice of dilatometer testing and is not intended to be a standard.

FOREWORD

This report on the flat dilatometer test is issued under the auspices of the ISSMGE Technical Committee TC16 (Ground Property Characterization from In-Situ Testing).

It was authored by the Geotechnical Group of L'Aquila University (Italy), with additional input from other members of the Committee.

The first outline of this report was discussed at the TC16 meeting in Atlanta – ISC '98 (April 1998).

The first draft was presented and discussed at the TC16 meeting in Amsterdam – 12th ECSMGE (June 1999).

Members of the Committee and other experts were invited to review the draft and provide comments. These comments have been taken into account and incorporated in this report.

AIMS OF THE REPORT

This report describes the use of the flat dilatometer test (DMT) in soil investigations. The main aims of the report are:

- To give a general overview of the DMT and of its design applications
- To provide "state of good practice" guidelines for the proper execution of the DMT
- To highlight a number of significant recent findings and practical developments.

This report is not intended to be (or to originate in the near future) a Standard or a Reference Test Procedure (RTP) on DMT execution.

Efforts have been made to preserve similarities in format with previous reports of the TC16 and other representative publications concerning in situ testing.

The content of this report is heavily influenced by the experience of the authors, who are responsible for the facts and the accuracy of the data presented herein.

Efforts have been made to keep the content of the report as objective as possible.

Occasionally subjective comments, based on the authors experience, have been included when considered potentially helpful to the readers.

SECTIONS OF THIS REPORT

PART A – PROCEDURE AND OPERATIVE ASPECTS

1. BRIEF DESCRIPTION OF THE FLAT DILATOMETER TEST
2. DMT EQUIPMENT COMPONENTS
3. FIELD EQUIPMENT FOR INSERTING THE DMT BLADE
4. MEMBRANE CALIBRATION
5. DMT TESTING PROCEDURE
6. REPORTING OF TEST RESULTS
7. CHECKS FOR QUALITY CONTROL
8. DISSIPATION TESTS

PART B – INTERPRETATION AND APPLICATIONS

9. DATA REDUCTION AND INTERPRETATION
10. INTERMEDIATE DMT PARAMETERS
11. DERIVATION OF GEOTECHNICAL PARAMETERS
12. PRESENTATION OF DMT RESULTS
13. APPLICATION TO ENGINEERING PROBLEMS
14. SPECIAL CONSIDERATIONS
15. CROSS RELATIONS WITH RESULTS FROM OTHER IN SITU TESTS

BACKGROUND AND REFERENCES

BACKGROUND

The flat dilatometer test (DMT) was developed in Italy by Silvano Marchetti. It was initially introduced in North America and Europe in 1980 and is currently used in over 40 countries.

The DMT equipment, the test method and the original correlations are described by Marchetti (1980) "In Situ Tests by Flat Dilatometer", ASCE Jnl GED, Vol. 106, No. GT3. Subsequently, the DMT has been extensively used and calibrated in soil deposits all over the world.

BASIC DMT REFERENCES / KEY PAPERS

Various international standards and manuals are available for the DMT. An ASTM Suggested Method was published in 1986. A "Standard Test Method for Performing the Flat Plate Dilatometer" is currently being published by ASTM (2001). The test procedure is also standardized in the Eurocode 7 (1997). National standards have also been developed in various countries (e.g. Germany, Sweden). A comprehensive manual on the DMT was prepared for the United States Department of Transportation (US DOT) by Briaud & Miran in 1992. Design applications and new developments are covered in detail in a state of the art report by Marchetti (1997). A list of selected comprehensive DMT references is given here below.

STANDARDS

ASTM D6635-01 (2001). Standard Test Method for Performing the Flat Plate Dilatometer. Book of Standards Vol. 04.09.
Eurocode 7 (1997). Geotechnical design - Part 3: Design assisted by field testing, Section 9: Flat dilatometer test (DMT).

MANUALS

Marchetti, S. & Crapps, D.K. (1981). "Flat Dilatometer Manual". Internal Report of G.P.E. Inc.
Schmertmann, J.H. (1988). Rept. No. FHWA-PA-87-022+84-24 to PennDOT, Office of Research and Special Studies, Harrisburg, PA, in 4 volumes.
US DOT - Briaud, J.L. & Miran, J. (1992). "The Flat Dilatometer Test". Departm. of Transportation - Fed. Highway Administr., Washington, D.C., Publ. No. FHWA-SA-91-044, 102 pp.

STATE OF THE ART REPORTS

Lunne, T., Lacasse, S. & Rad, N.S. (1989). "State of the Art Report on In Situ Testing of Soils". Proc. XII ICSMFE, Rio de Janeiro, Vol. 4.
Lutenegger, A.J. (1988). "Current status of the Marchetti dilatometer test". Special Lecture, Proc. ISOPT-1, Orlando, Vol. 1.
Marchetti, S. (1997). "The Flat Dilatometer: Design Applications". Proc. Third International Geotechnical Engineering Conference, Keynote lecture, Cairo University, 28 pp.

CONFERENCES, SEMINARS, COURSES

Several conferences, seminars and courses have been dedicated to the DMT. The most important are mentioned here below.

- First International Conference on the Flat Dilatometer, Edmonton, Alberta (Canada), Feb. 1983.
- One-day Short Course on the DMT held by S. Marchetti in Atlanta (GA), USA, in connection with the First International Conference on Site Characterization (ISC '98), Apr. 1998.
- International Seminar on "The Flat Dilatometer and its Applications to Geotechnical Design" held by S. Marchetti at the Japanese Geotechnical Society, Tokyo, Feb. 1999.

DMT ON THE INTERNET

Key papers on the DMT can be downloaded from the bibliographic site: <http://www.marchetti-dmt.it>

PART A

PROCEDURE AND OPERATIVE ASPECTS

1. BRIEF DESCRIPTION OF THE FLAT DILATOMETER TEST

The flat dilatometer is a stainless steel blade having a flat, circular steel membrane mounted flush on one side (Fig. 1).

The blade is connected to a control unit on the ground surface by a pneumatic-electrical tube (transmitting gas pressure and electrical continuity) running through the insertion rods. A gas tank, connected to the control unit by a pneumatic cable, supplies the gas pressure required to expand the membrane. The control unit is equipped with a pressure regulator, pressure gage(s), an audio-visual signal and vent valves.



Fig. 1. The flat dilatometer - Front and side view

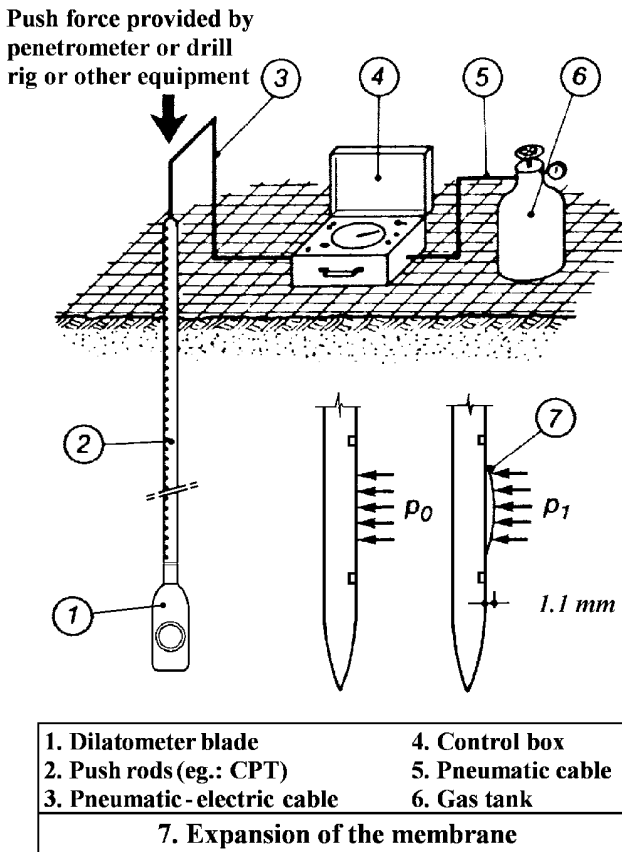

Fig. 2. General layout of the dilatometer test

The blade is advanced into the ground using common field equipment, i.e. push rigs normally used for the cone penetration test (CPT) or drill rigs. Push rods are used to transfer the thrust from the insertion rig to the blade.

The general layout of the dilatometer test is shown in Fig. 2. The test starts by inserting the dilatometer into the ground. Soon after penetration, by use of the control unit, the operator inflates the membrane and takes, in about 1 minute, two readings:

- 1) the *A*-pressure, required to just begin to move the membrane against the soil ("lift-off")
- 2) the *B*-pressure, required to move the center of the membrane 1.1 mm against the soil.

A third reading *C* ("closing pressure") can also optionally be taken by slowly deflating the membrane soon after *B* is reached.

The blade is then advanced into the ground of one depth increment (typically 20 cm) and the procedure for taking *A*, *B* readings is repeated at each depth.

The pressure readings *A*, *B* must then be corrected by the values ΔA , ΔB determined by calibration, to take into account the membrane stiffness, and converted into p_0 , p_1 .

The *field of application* of the DMT is very wide, ranging from extremely soft soils to hard soils/soft rocks. The DMT is suitable for sands, silts and clays,

where the grains are small compared to the membrane diameter (60 mm). It is not suitable for gravels. However the blade is robust enough to cross gravel layers of about 0.5 m thickness.

Due to the balance of zero pressure measurement method (null method), the DMT readings are highly accurate even in extremely soft - nearly liquid soils. On the other hand the blade is very robust (can safely withstand up to 250 kN of pushing force) and, if the thrust provided by the rig is sufficient, can penetrate even soft rocks. Clays can be tested from $c_u = 2-4$ kPa up to 1000 kPa (marls). The range for moduli *M* is from 0.4 MPa up to 400 MPa.

2. DMT EQUIPMENT COMPONENTS

The basic equipment for dilatometer testing consists of the components shown in Fig. 2.

2.1 DILATOMETER BLADE

2.1.1 Blade and membrane characteristics

The nominal dimensions of the blade are 95 mm width and 15 mm thickness. The blade has a cutting edge to penetrate the soil. The apex angle of the edge is 24° to 32°. The lower tapered section of the tip is 50 mm long. The blade can safely withstand up to 250 kN of pushing thrust.

The circular steel membrane is 60 mm in diameter. Its normal thickness is 0.20 mm (0.25 mm thick membranes are sometimes used in soils which may cut the membrane). The membrane is mounted flush on the blade and kept in place by a retaining ring.

2.1.2 Working principle

The working principle of the DMT is illustrated in Fig. 3 (see also the photo in Fig. 4). The blade works as an electric switch (*on/off*). The insulating seat prevents electrical contact of the sensing disc with the underlying steel body of the dilatometer. The sensing disc is stationary and is kept in place press-fitted inside the insulating seat. The contact is signaled by an audio/visual signal. The sensing disc is grounded (and the control unit emits a sound) under one of the following circumstances:

- 1) the membrane rests against the sensing disc (as prior to membrane expansion)
- 2) the center of the membrane has moved 1.1 mm into the soil (the spring-loaded steel cylinder makes contact with the overlying sensing disc).

There is no electrical contact, hence no signal, at intermediate positions of the membrane.

When the operator starts increasing the internal pressure (Fig. 3), for some time the membrane does not move and remains in contact with its metal

WORKING PRINCIPLE

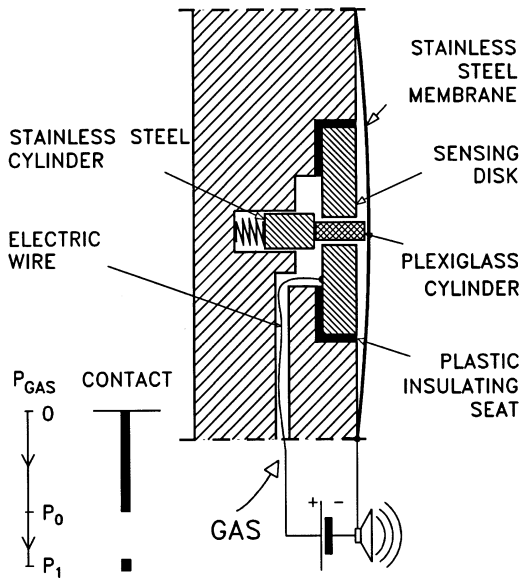

Fig. 3. DMT working principle



Fig. 4. Particular of the DMT blade

support (signal *on*). When the internal pressure counterbalances the external soil pressure, the membrane initiates its movement, losing contact with its support (signal *off*). The interruption of the signal prompts the operator to read the "lift-off" *A*-pressure (later corrected into p_0). The operator, without stopping the flow, continues to inflate the membrane (signal *off*). When the movement of the membrane center reaches 1.1 mm, the spring-loaded steel cylinder touches (and grounds) the bottom of the sensing disc, reactivating the signal. The reactivation of the signal prompts the operator to read the "full expansion" *B*-pressure (later corrected into p_1).

The top of the sensing disc carries a 0.05 mm feeler having the function to improve the definition of the lift-off of the membrane, i.e. the instant at which the electrical circuit is interrupted.

The fixed-displacement system insures that the membrane expansion will be $1.10 \text{ mm} \pm 0.02 \text{ mm}$, since the operator cannot vary or regulate such distance. Only calibrated quartz (once plexiglas) cylinders (height $3.90 \pm 0.01 \text{ mm}$) should be used to insure accuracy of the prefixed movement.

NOTE: Remarks on the DMT working principle

- The membrane expansion is not a load controlled test - apply the load and observe settlement - but a displacement controlled test - fix the displacement and measure the required pressure. Thus in all soils the central displacement (and, at least approximately, the strain pattern imposed to the soil) is the same.
- The membrane is not a measuring organ but a passive separator soil-gas. The measuring organ is the gage at ground surface. The accuracy of the measurements is that of the gage. The zero offset of the gage can be checked at any time, being at the surface. A low range pressure gage can be used, e.g. in very soft soils, to increase accuracy to any desired level.
- The method of pressure measurement is the balance of zero (null method), providing high accuracy.
- The blade works as an electric switch (*on/off*), without electronics or transducers.
- Given the absence of delicate or regulable components, no special skills are required to operate the DMT.

2.2 CONTROL UNIT

2.2.1 Functions and components

The control unit on ground surface is used to measure the *A*, *B* (*C*) pressures at each test depth.

The control unit (Fig. 5) typically includes two pressure gages, a pressure source quick connect, a quick connect for the pneumatic-electrical cable, an electrical ground cable connection, a galvanometer and audio buzzer signal (activated by the electric switch constituted by the blade) which prompt when to read the *A*, *B* (*C*) pressures, and valves to control gas flow and vent the system.



Fig. 5. Control unit

2.2.2 Pressure gages

The two pressure gages, connected in parallel, have different scale ranges: a low-range gage (1 MPa), self-excluding when the end of scale is reached, and a high-range gage (6 MPa). The two-gage system ensures proper accuracy and, at the same time, sufficient range for various soil types (from very soft to very stiff).

According to Eurocode 7 (1997), the pressures should be measured with a resolution of 10 kPa and a reproducibility of 2.5 kPa, at least for pressures lower than 500 kPa. Gages should have an accuracy of at least 0.5 % of span.

In case of discrepancy between the two gages, replace the malfunctioning gage or correct as appropriate. In case of single-gage (old control units), the gage should be periodically calibrated.

Though the control unit is encased in an aluminium carrying case, it should be handled with care to avoid damaging the gages.

2.2.3 Gas flow control valves

The valves on the control unit panel permit to control the gas flow to the blade.

The *main valve* provides a positive shutoff between the gas source and the control unit-blade system. The *micrometer flow valve* is used to control the rate of flow during the test. It also provides a shutoff between the source and the DMT system (anyway, if the control unit is left unattended for some time, it is advisable to close the *main valve* and to open the *toggle vent valve*). The *toggle vent valve* allows the operator to vent quickly the system pressure to the atmosphere. The *slow vent valve* allows to vent the system slowly for taking the *C*-reading.

2.2.4 Electrical circuit

The electrical circuitry in the control unit has the scope of indicating the *on/off* condition of the blade-switch. It provides both a visual galvanometer and an audio buzzer signal to the operator. The buzzer is *on* when the blade is in the short circuit condition, i.e. membrane collapsed against the blade or fully expanded. The buzzer is *off* when between these two positions. The transitions from buzzer *on* to *off* (at lift-off) and then *off* to *on* (at the end of expansion) are the prompts for the operator to take respectively the *A* and *B* pressure readings.

A 9-Volt battery supplies electrical power to the wire inside the pneumatic-electrical cable. The power is returned at the ground cable jack if the blade is in the short circuit condition.

A test button permits to check the vitality of the battery and the operation of the galvanometer and buzzer. Note that this button simply shorts across the

control unit portion of the circuit and hence provides no information about the status of the blade, the pneumatic-electrical cable or the ground cable. If annoyed by the sound during test delays, the operator may disable the buzzer. However, quieting the buzzer involves the risk of missing to switch it on again, then missing the prompts to take the readings and overinflating the membrane.

2.3 PNEUMATIC-ELECTRICAL CABLE

The pneumatic-electrical (p-e) cable provides pneumatic and electrical continuity between the control unit and the dilatometer blade. It consists of a stainless steel wire enclosed within nylon tubing with special metal connectors at either end. Two different cable types are normally used (Fig. 6):

- *Non-extendable cable*: this cable has an insulated male metal connector for the DMT blade on one end, and a non-insulated quick-connect for attachment to the control unit on the other end. The cable length (a working length at the surface should also be accounted for) limits the maximum sounding depth: once the test depth is such that all the cable is inside the soil, the cable cannot be extended and the test must be stopped. This inconvenience is balanced by the simplicity of the cable and its lower cost.
- *Extendable cable*: by using an extendable cable, the operator may connect additional cable(s) as needed during the sounding. The female terminal of such cable (insulated) cannot fit directly into the corresponding quick connector in the control unit. Therefore a *cable leader* (or *short connector cable*) permitting such a connection must be used in conjunction with this cable. This short adaptor is removed when a new cable is added. Though slightly more complex, this type of cable provides the operator with greater flexibility.

The proper type and length of cable should be chosen based on the anticipated sounding depth. For ease of handling and to minimize pressure lag in the entire system, it is recommended to use the shortest length practical.

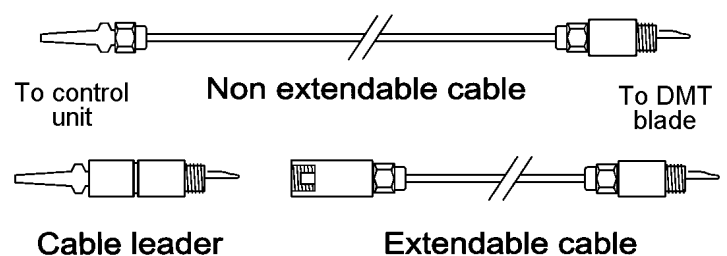

Fig. 6. Types of pneumatic-electrical cables

Short cables are easier to handle, but require junctions. Junctions normally work well and do not represent a problem as long as care is exercised to avoid particles of soils getting into the conduits.

To keep contaminants out, the terminals and connectors must always be protected with caps when disconnected.

The metal connectors are electrically insulated from the inner wire to prevent a short circuit in the ground and sealed by washers to prevent gas leakage.

The cables and terminals are not easily repairable in the field.

2.4 GAS PRESSURE SOURCE

The pressure source is a gas tank equipped with a pressure regulator, valves and pneumatic tubing to connect to the control unit.

The pressure regulator (suitable to gas type) must be able to supply a regulated output pressure of at least 7-8 MPa.

When testing in most soils the output pressure is set at 3-4 MPa. In very hard soils the output pressure is further increased (without exceeding the high-range gage capacity).

Any non flammable, non corrosive, non toxic gas may be used. Compressed nitrogen or compressed air (scuba tanks) are most generally used.

Gas consumption increases with applied pressure (*A*, *B* readings) and test depth (cable length). In "average" soils a scuba size tank (≈ 0.6 m high), initially at 15 MPa, contains gas to perform approximately 70-100 m of "standard" sounding (\approx one day of testing). In general, it is more economical and efficient to have a large tank (≈ 1.5 m high) when more than one day of testing is anticipated.

2.5 ELECTRICAL GROUND CABLE

The ground cable provides electrical continuity between the push rods and the control unit. It returns to the control unit the simple *on/off* electrical power carried to the blade by the pneumatic-electrical cable.

3. FIELD EQUIPMENT FOR INSERTING THE DMT BLADE

3.1 PUSHING EQUIPMENT

The dilatometer blade is advanced into the ground using common field equipment.

The blade can be pushed with a cone penetrometer rig or with a drill rig (Fig. 7).

The penetration rate is usually 2 cm/s as in the CPT (for DMT rates from 1 to 3 cm/s are acceptable, see Eurocode 7 1997).

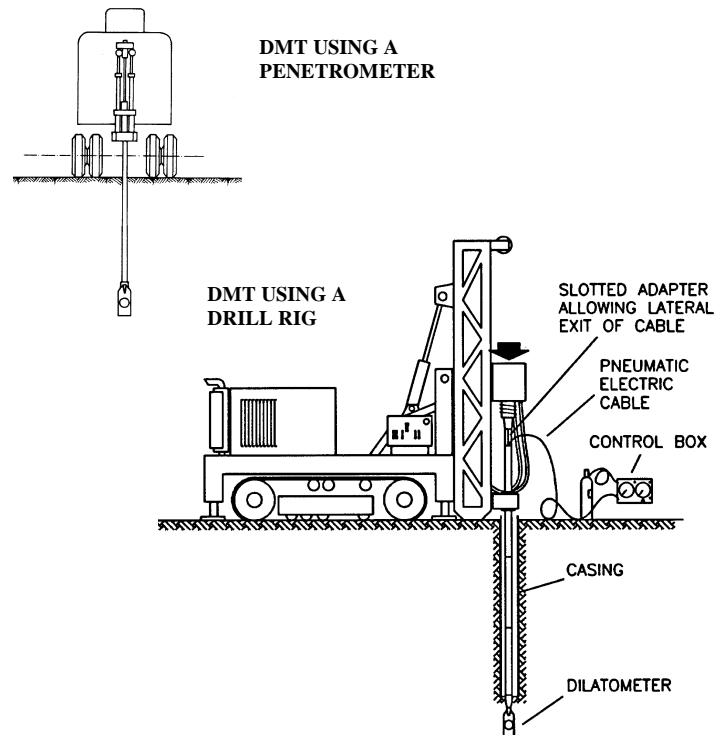

Fig. 7. Equipment for inserting the DMT blade

The DMT can also be driven, e.g. using the SPT hammer and rods, but statical push is by far preferable.

Heavy truck-mounted penetrometers are incomparably more efficient than drill rigs. Moreover the soil provides lateral support to the rods (which is not the case in a borehole). Pushing the blade with a 20 ton penetrometer truck is most effective and yields the highest productivity (up to 80 m of sounding per day).

Drill rigs or light rigs may be used only in soft soils or to very short depths. In all other cases (especially in hard soils) light rigs may be inadequate and source of problems. However drill rigs may be necessary in soils containing occasional boulders or hard layers, where the obstacle-destroying capability will permit to continue the test past the obstacle.

When the DMT sounding is resumed after preboring, the initial test results, obtained in the zone of disturbance at hole bottom (≈ 3 to 5 borehole diameters), should be regarded with caution.

When the DMT is performed inside a borehole, the diameter of the borehole (and casing, if required) should be as small as possible to minimize the risk of buckling (possibly 100-120 mm).

In all cases the penetration must occur in "fresh" (not previously penetrated) soil. The minimum recommended distance from other nearby DMT (or CPT) soundings is 1 m (25 borehole diameters from unbackfilled/uncased borings).

NOTE: Possible problems with light rigs

Possible problems with light rigs (such as many SPT rigs) are:

- Light rigs have typically a pushing capacity of only 2 tons, hence refusal is found very soon (not rarely at 1-2 m depth).
- Often there is no collar near ground surface (i.e. no ground surface side-guidance of the rods).
- Often there is a hinge-type connection in the rods just below the pushing head, which permits excessive freedom and oscillations of the rods inside the hole.
- The distance between the pushing head of the rig and the bottom of the hole is several meters, hence the free/buckling length of the rods is high. In some cases the loaded rods have been observed to assume a "Z" shape.
- Oscillations of the rods may cause wrong results. In case of short penetration in hard layers it was occasionally observed that the "Z" shape of the rods suddenly reverted to the opposite side. This is one of the few cases in which the DMT readings may be instrumentally incorrect: oscillations of the rods cause tilting of the blade, and the membrane is moved without control close to/far from the soil.

NOTE: Pushing vs driving

Various researchers (US DOT 1992, Schmertmann 1988) have observed that "hammer-driving alters the DMT results and decreases the accuracy of correlations", i.e. the insertion method does affect the test results, and static penetration should be preferred.

According to ASTM (1986), in soils sensitive to impact and vibrations, such as very loose sand or very sensitive clays, dynamic insertion methods can significantly change the test results compared to those obtained using a static push. In general, structurally sensitive soils will appear conservatively more compressible when tested using dynamic insertion methods. In such cases the engineer may need to check such dynamic effects and, possibly, calibrate and adjust test interpretation accordingly. US DOT (1992) recommends that, if the driving technique is used, as a minimum 2 soundings be performed side by side, one by pushing and one by driving. This would give a site/soil specific correlation, which would allow to get back to the parameters obtained from correlations based on the pushing insertion (with added imprecision, however).

According to Eurocode 7 (1997), driving should be avoided except when advancing the blade through stiff or strongly cemented layers which cannot be penetrated by static push.

3.2 PUSH RODS

While in principle any kind of rod can be used, most commonly CPT rods or drill rig rods are employed.

A friction reducer is sometimes used. However the consequent reduction in rod friction is moderate, because of the multi-lobate shape of the cavity produced in the penetrated soil by the blade-rod system.

If used, the friction reducer should be located at least 200 mm above the center of the membrane (Eurocode 7 1997).

NOTE: Use of stronger rods

Many heavy penetrometer trucks performing DMT are today also equipped with rods much stronger than the common 36 mm CPT rods. Such stronger rods are typically 44 to 50 mm in diameter, 1 m length, same steel as CPT rods (yield strength > 1000 MPa).

A very suitable and convenient type of rod is the commercially available 44 mm rod used for pushing 15 cm² cones.

The stronger rods have been introduced since the rods are "the weakest element in the chain" when working with heavy trucks and the current high strength DMT blades, able to withstand a working load of approximately 250 kN.

The stronger rods have several advantages:

- Capability of penetrating through cemented layers/obstacles.
- Better lateral stability against buckling in the first few meters in soft soils or when the rods are pushed inside an empty borehole.
- Possibility of using completely the push capacity of the truck.
- Reduced risk of deviation from the verticality in deep tests.
- Drastically reduced risk of losing the rods.

Obvious drawbacks are the initial cost and the heavier weight. Also, their use may not be convenient in OC clay sites because of the increased skin friction.

3.3 ROD ADAPTORS

The DMT blade is connected to the push rods by a *lower adaptor* (Fig. 8).

The most common adaptor has its top connectable to CPT rods, its bottom connectable to the DMT blade (ending cylindrical male M27x3mm).

If rods other than CPT rods are used, specific adaptors need to be prepared (see Fig. 8).

An *upper slotted adaptor* is also needed to allow lateral exit of cable, otherwise pinched by the pushing head.

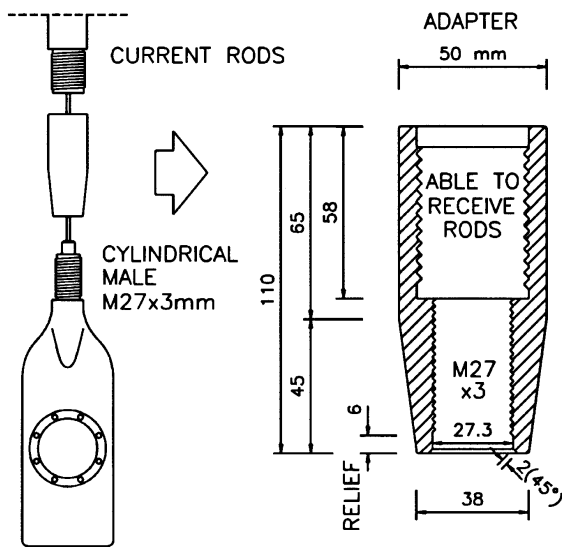

Fig. 8. Lower adaptor connecting the DMT blade to the push rods

When using a CPT truck, a DMT sounding normally starts from the ground surface, with the tube running inside the rods (Fig. 9a, left).

When testing starts from the bottom of a borehole, the pneumatic-electrical (p-e) cable can either run all the way up inside the rods, or can exit laterally from the rods at a suitable distance above the blade (Fig. 9a, right). In this case an additional *intermediate slotted adaptor* is needed to permit egress of the cable (Fig. 9a, right). Above this point the cable is taped to the outside of the rods at 1-1.5 m intervals up to the surface.

The torpedo-like bottom assembly in Fig. 9a is composed by the blade, 3 to 5 m (generally) of rods and the *intermediate slotted adaptor*. The "torpedo" is pre-assembled and then mounted at the end of the rods each time. The "torpedo" arrangement speeds production, since it is easier to handle the upper rods, in this case free from the cable.

Since the unprotected cable is vulnerable, the *intermediate slotted adaptor* needs a special collar (Fig. 9b). The collar has a vertical channel for the cable and has a diameter larger than the upper rods so as to insure a free space between the upper rods and the casing. The operator should not allow the slotted adaptor and the exposed cable to penetrate the soil, thus limiting the test depth to the length of rods threaded at the bottom.

4. MEMBRANE CALIBRATION

4.1 DEFINITIONS OF ΔA AND ΔB

The calibration procedure consists in obtaining the ΔA and ΔB pressures necessary to move the membrane to the *A* and *B* positions in absence of soil. ΔA and ΔB would be zero if the membrane had

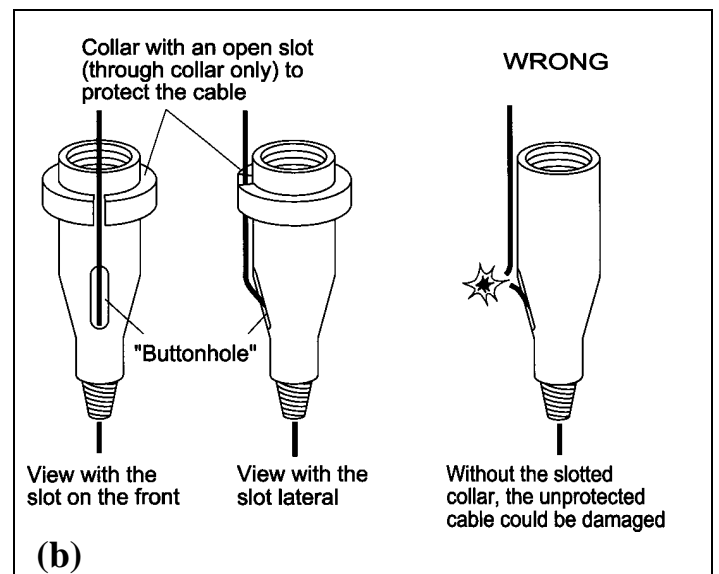
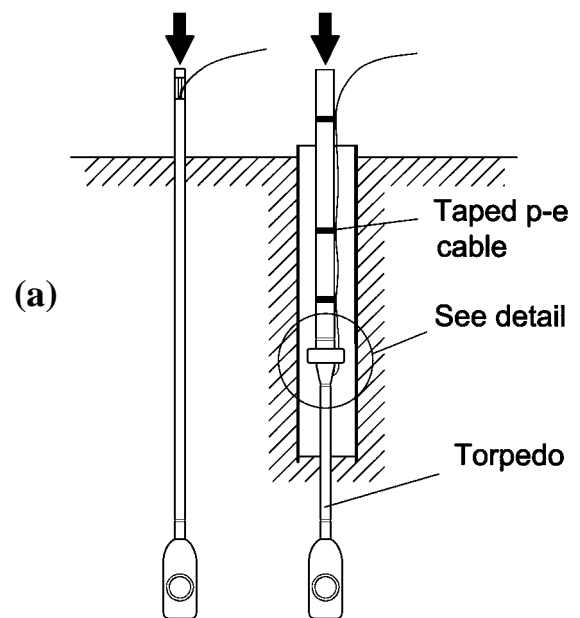

Fig. 9. (a) Possible exits of the cable from the rods (b) Intermediate slotted adaptor joining the upper push rods to the torpedo-like bottom assembly of blade and rods

an infinitesimal thickness. ΔA and ΔB are then used to correct the *A*, *B* readings.

Note that in air, under atmospheric pressure, the free membrane is in an intermediate position between the *A* and *B* positions, because the membranes have a slight natural outward curvature (Fig. 10).

ΔA is the external pressure which must be applied to the membrane, in free air, to collapse it against its seating (i.e. *A*-position). ΔB is the internal pressure which, in free air, lifts the membrane center 1.1 mm from its seating (i.e. *B*-position).

Various aspects related to the membrane calibration are described in detail by Marchetti (1999) and Marchetti & Crapps (1981).

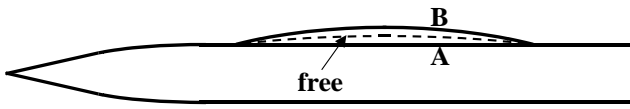

Fig. 10. Positions of the membrane (free, A and B)

NOTE: Meaning of the term "calibration"

The membrane calibration is not, strictly speaking, a *calibration*, since the term calibration usually refers to the scale of a measuring instrument. The membrane, instead, is a passive separator gas/soil and not a measuring instrument. Actually the membrane is a "tare" and the "calibration" is in reality a "tare determination".

4.2 DETERMINATION OF ΔA AND ΔB

ΔA and ΔB can be measured by a simple procedure using a syringe to generate vacuum or pressure.

During the calibration the high pressure from the bottle should be excluded from the pneumatic circuit by closing the *main valve* on the control unit panel.

To obtain ΔA : quickly pull back (almost fully) the piston of the syringe, in order to apply the maximum vacuum possible (the vacuum causes an inward deflection of the membrane similar to that resulting from the external soil pressure at the start of the test). Hold the piston for sufficient time (at least 5 seconds) for the vacuum to equalize in the system. During this time the buzzer signal should become active. Then slowly release the piston and read ΔA on the low-range gage (gage vacuum reading at which the buzzer stops, i.e. *A*-position). Note this negative pressure as a positive value (e.g. a vacuum of 15 kPa should be reported as $\Delta A = 15$ kPa). The correction formula for p_0 (Eq. 1 in Section 9.2) is already adjusted to take into account that a positive ΔA is a vacuum.

To obtain ΔB : push slowly the piston into the syringe and read ΔB on the low-range gage when the buzzer reactivates (i.e. *B*-position).

Repeat this procedure several times to have a positive check of the values being read.

Membrane corrections ΔA , ΔB should be measured before a sounding, at the end of a sounding, and whenever the blade is removed from the ground.

ΔA , ΔB are usually measured, as a check, in the office before moving to the field. However the initial ΔA , ΔB to be used are those taken just before the sounding (though the difference is generally negligible).

The calibration values of an undamaged membrane remain relatively constant during a DMT sounding. Comparison of before/after values provides a useful indication on the condition of the membrane.

E.g. a large difference should prompt a membrane change. Therefore, the calibration procedure is a good indicator of the equipment condition, and consequently of the quality of the data.

4.3 ACCEPTANCE VALUES OF ΔA AND ΔB

Acceptance values of ΔA , ΔB are indicated in Eurocode 7 (1997).

- The initial ΔA , ΔB values must be in the following ranges: $\Delta A = 5$ to 30 kPa, $\Delta B = 5$ to 80 kPa. If the values of ΔA , ΔB obtained before inserting the blade into the soil fall outside the above limits, the membrane shall be replaced before testing.
- The change of ΔA or ΔB between the beginning and the end of the sounding must not exceed 25 kPa, otherwise the test results shall be discarded.

Typical values of ΔA , ΔB are: $\Delta A = 15$ kPa, $\Delta B = 40$ kPa.

ΔA , ΔB values also indicate when it is time to replace a membrane. An old membrane needs not to be replaced as long as ΔA , ΔB are in tolerance.

Indeed an old membrane is preferable, in principle, to a new one, having more stable and lower ΔA , ΔB . However, in case of bad wrinkles, scratches, etc. a membrane should be changed even if ΔA , ΔB are in tolerance (though ΔA , ΔB are not likely to be in tolerance if the membrane is in a really bad shape).

4.4 CONFIGURATIONS DURING THE CALIBRATION

The membrane calibration (determining ΔA , ΔB) can be performed in two configurations.

- 1) The first configuration (*blade accessible*, Fig. 11) is adopted e.g. at the beginning of a sounding, when the blade is still in the hands of the operator.

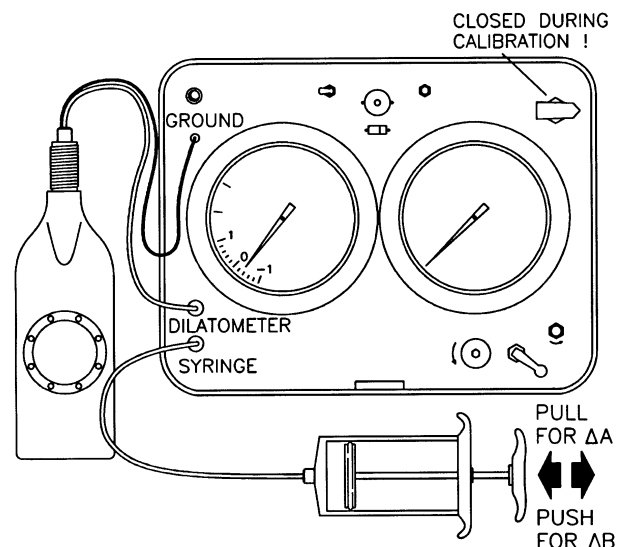

Fig. 11. Layout of the connections during membrane calibration (blade accessible)

The operator will then use the *short calibration cable*, or the *short calibration connector*.

- 2) The second configuration (*blade not readily accessible*) is used when the blade is under the penetrometer, and is connected to the control unit as during current testing (Fig. 12) with cables of normal length (say 20 to 30 m).

The calibration procedure is the same. The only difference is that, in the second case, due to the length of the DMT tubings, there is some time lag (easily recognizable by the slow response of the pressure gages to the syringe). Therefore, in that configuration, ΔA , ΔB must be taken slowly (say 15 seconds for each determination).

4.5 EXERCISING THE MEMBRANE

The exercising operation is to be performed whenever a new membrane is mounted. A new membrane needs to be "exercised" in order to stabilize ΔA , ΔB values (obtain ΔA , ΔB values which will remain constant during the sounding).

The exercising operation simply consists in pressurizing the blade in free air at about 500 kPa for a few seconds two or three times.

If the membrane exercising is performed with the blade submerged in water, it is possible to verify blade airtightness.

After exercising, verify that ΔA , ΔB are in tolerance: $\Delta A = 5$ to 30 kPa (typically 15 kPa), $\Delta B = 5$ to 80 kPa (typically 40 kPa).

4.6 IMPORTANCE OF ACCURATE ΔA AND ΔB

The importance of accurate ΔA , ΔB measurements, especially in soft soils, is pointed out by Marchetti (1999). Inaccurate ΔA , ΔB are virtually the only potential source of DMT instrumental error. Since ΔA , ΔB are used to correct all A , B of a sounding, any inaccuracy in ΔA , ΔB would propagate to all the data.

The importance of ΔA , ΔB in soft soils derives from the fact that, in the extreme case of nearly liquid clays, or liquefiable sands, A and B are small numbers, just a bit higher than ΔA , ΔB . Since the correction involves differences between similar numbers, accurate ΔA , ΔB are necessary in such soils.

ΔA , ΔB must be, as a rule, measured before and after each sounding. Their average is subsequently used to correct all A , B readings. Clearly, if the variation is small, the average represents ΔA , ΔB reasonably well at all depths. If the variation is large, the average may be inadequate at some depths. In fact, in soft soils, the operator can be sure that the test results are acceptable only at the end of the

sounding, when, checking ΔA , ΔB final, he finds that they are very similar to ΔA , ΔB initial.

In medium to stiff soils ΔA , ΔB are a small part of A and B , so small inaccuracies in ΔA , ΔB have negligible effect.

NOTE: How ΔA , ΔB can go out of tolerance

In practice the only mechanism by which ΔA , ΔB can go out of tolerance is *overinflating the membrane* far beyond the B -position. Once overinflated, a membrane requires excessive suction to close (ΔA generally > 30 kPa), and even ΔB may be a suction.

5. DMT TESTING PROCEDURE

5.1 PRELIMINARY CHECKS AND OPERATIONS BEFORE TESTING

Select for testing only blades respecting the tolerances (have available at least two). Similarly, use only properly checked pieces of equipment.

Pre-thread the pneumatic-electrical (p-e) cable through a suitable number of push rods and the adaptors. During this operation keep the cable terminals protected from dirt with the caps.

Wrench-tighten the cable terminal to the blade. Connect the blade to the bottom push rod (with interposed the *lower adaptor*). Avoid excessive twists in the cable while making the connections.

Insert the electrical ground cable plug into the "ground" jack of the control unit. Clip the other end (electrical alligator clip) to the *upper slotted adaptor* or to one of the push rods (not to the metal frame of the rig, which may be not in firm electrical contact with the rods).

The connections should be as indicated in Fig. 12 (but do not open the valve of the bottle yet!).

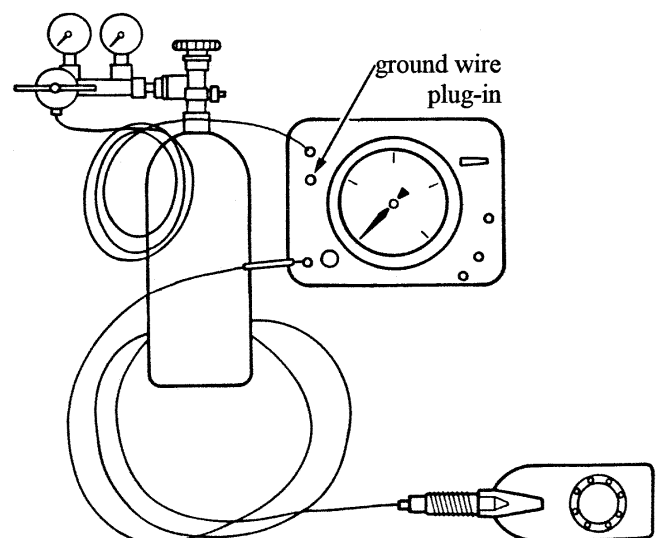

Fig. 12. Layout of the connections during current testing

Check the electrical continuity and the switch mechanism by pressing the center of the membrane. The signal should activate. If not, make the appropriate repair.

Record the zero of the gage Z_M (reading of the gage for zero pressure) by opening the *toggle vent valve* and read the pressure while tapping gently on the glass of the gage.

Perform the calibration as described in detail in Section 4.

With the gas tank valve closed, connect the pressure regulator to the tank. Set the regulated pressure to zero (fully unscrew the regulating lever).

Connect the pneumatic cable from the gas tank regulator to the control unit female quick connector marked "pressure source".

Make sure that: the *main valve* is closed, the *toggle vent valve* is open and the *micrometer flow valve* is closed.

Open the tank valve. Set the regulator so that the pressure supplied to the control unit is about 3 MPa (this pressure can be later increased if necessary).

Open the *main valve*. (This valve normally remains always open during current testing. During current testing the operator only uses the *micrometer flow valve* and the *vent valves*).

5.2 STEP-BY-STEP TEST PROCEDURE (A, B, C READINGS)

The DMT test consists in the following sequence of operations.

- 1) The DMT operator makes sure that the *micrometer flow valve* is closed and the *toggle vent valve* open, then he gives the go-ahead to the rig operator (the two operators should position themselves in such a way they can exchange control and visual communication easily).
- 2) The rig operator pushes the blade vertically into the soil down to the selected test depth, either from ground surface or from the bottom of a borehole. During the advancement the signal (galvanometer and buzzer) is normally *on* because the soil pressure closes the membrane. (The signal generally starts at 20 to 40 cm below ground surface).
- 3) As soon as the test depth is reached, the rig operator releases the thrust on the push rods and gives the go-ahead to the DMT operator.
- 4) The DMT operator closes the *toggle vent valve* and slowly opens the *micrometer flow valve* to pressurize the membrane. During this time he hears a steady audio signal or buzzer on the control unit. At the instant the signal stops (i.e. when the membrane lifts from its seat and just

begins to move laterally), the operator reads the pressure gage and records the first pressure reading *A*.

- 5) Without stopping the flow, the DMT operator continues to inflate the membrane (during this phase signal is *off*) until the signal reactivates (i.e. membrane movement = 1.1 mm). At this instant the operator reads at the gage the second pressure reading *B*. After mentally noting or otherwise recording this value, he must do the following four operations:

- 1 - Immediately open the *toggle vent valve* to depressurize the membrane.
- 2 - Close the *micrometer flow valve* to prevent further supply of pressure to the dilatometer (these first two operations prevent further expansion of the membrane, which may permanently deform it and change its calibrations, and must be performed quickly after the *B*-reading, otherwise the membrane may be damaged).
- 3 - Give the rig operator the go-ahead to advance one depth increment - generally 20 cm (during penetration the *toggle vent valve* must remain open to avoid pushing the blade with the membrane expanded).
- 4 - Write the second reading *B*.

Repeat the above sequence at each depth until the end of the sounding. At the end of the sounding, when the blade is extracted, perform the final calibration.

If the *C*-reading is to be taken, there is only one difference in the above sequence. In Step 5.1, after the *B* reading, open the *slow vent valve* instead of the fast *toggle vent valve* and wait (approximately 1 minute) until the pressure drops approaching the zero of the gage. At the instant the signal *returns* take the *C*-reading. Note that, in sands, the value to be expected for *C* is a low number, usually < 100-200 kPa, i.e. 10 or 20 m of water.

NOTE: Frequent mistake in C-readings

As remarked in DMT Digest Winter 1996 (edited by GPE Inc., Gainesville, Florida), several users have reported poor *C*-readings, mostly due to improper technique. The frequent mistake is the following. After *B*, i.e. when the slow deflation starts, the signal is *on*. After some time the signal stops (from *on* to *off*). The mistake is to take the pressure at this inversion as *C*, which is incorrect (at this time the membrane is the *B*-position). The correct instant for taking *C* is some time later, when, completed the deflation, after say 1 minute, the membrane returns to the "closed" *A*-position, thereby contacting the supporting pedestal and reactivating the signal.

NOTE: Frequency of C-readings

(a) Sandy sites

In sands ($B \geq 2.5 A$) C -readings may be taken sporadically, say every 1 or 2 m, and are used to evaluate u_0 (equilibrium pore pressure). It is advisable to repeat the A - B - C cycle several times to insure that all cycles provide similar C -readings.

(b) Interbedded sands and clays

If the interest is limited to finding the u_0 profile, then C -readings are taken in the sandy layers ($B \geq 2.5 A$), say every 1 or 2 m.

When the interest, besides u_0 , is to discern free-draining layers from non free-draining layers, then C -readings are taken at each test depth.

NOTE: Electrical connections during testing

The rig operator should never disconnect the ground cable (e.g. to add a rod which requires to remove the electrical alligator) while the DMT operator is taking the readings and anyway not before his go-ahead indication.

NOTE: Expansion rate

Pressures A and B must be reached slowly.

According to the Eurocode 7 (1997), the rate of gas flow to pressurize the membrane shall be such that the A -reading is obtained (typically in 15 seconds) within 20 seconds from reaching the test depth and the B -reading (expansion from A to B) within 20 seconds after the A -reading. As a consequence, the rate of pressure increase is very slow in weak soils and faster in stiff soils.

The above time intervals typically apply for cables lengths up to approximately 30 m. For longer cables the flow rate may have to be reduced to allow pressure equalization along the cable.

During the test, the operator may occasionally check the adequacy of the selected flow rate by closing the *micrometer flow valve* and observing how the pressure gage reacts. If the gage pressure drops in excess of 2 % when closing the valve (ASTM 1986), the rate is too fast and must be reduced.

NOTE: Time required for the test

The time delay between end of pushing and start of inflation is generally 1-2 seconds. The complete test sequence (A , B readings) generally requires about 1 minute. The total time needed for obtaining a "typical" 30 m profile (if no obstructions are found) is about 3 hours. The C -reading adds about 45 seconds to 1 minute to the time required for the DMT sequence at each depth.

NOTE: Depth increment

A smaller depth increment (typically 10 cm) can be

assumed, even limited to a single portion of the DMT sounding, whenever more detailed soil profiling is required.

NOTE: Test depths

The test depths should be recorded with reference to the center of the membrane.

NOTE: Thrust measurement

Some Authors or existing standards (Schmertmann 1988, ASTM 1986, ASTM 2001) recommend the measurement of the thrust required to advance the blade as a routine part of the DMT testing procedure.

The specific aim of this additional measurement is to obtain q_D (penetration resistance of the blade tip). q_D permits to estimate K_0 and Φ in sand according to the method formulated by Schmertmann (1982, 1983).

Measuring q_D directly is highly impractical. One way of obtaining q_D is to derive it from the thrust force, measurable by a properly calibrated load cell.

The preferable location of such load cell would be immediately above the blade to exclude the rod friction (however the lateral friction on the blade has still to be detracted). Even this cell location is impractical and not presently adopted except for research purposes, so that the load cell, when used, is generally located above the ground surface.

Practical alternative methods for estimating q_D are indicated in ASTM (1986): (a) Measure the thrust at the ground surface and subtract the estimated parasitic rod friction above the blade. (b) Measure both the thrust needed for downward penetration and the pull required for upward withdrawal: the difference gives an estimate of q_D . (c) If values of the cone penetration resistance q_c from adjacent CPT are available, assume $q_D \approx q_c$ (e.g. ASTM 1986, Campanella & Robertson 1991, ASTM 2001).

6. REPORTING OF TEST RESULTS ("FIELD RAW DATA")

A typical DMT field data form is shown in Fig. 13.

Besides the field raw data, the test method should be described, or the reference to a published standard indicated.

7. CHECKS FOR QUALITY CONTROL

7.1 CHECKS ON HARDWARE

7.1.1 Blade

Membrane corrections tolerances

Verify that all blades available at the site are within tolerances (initial $\Delta A = 5$ to 30 kPa, initial $\Delta B = 5$ to 80 kPa).

Typical: 0.15 0.40

FIRM (max characters no.=32)	BLADE No. ↓	ΔA (bar) <small>0.05-0.20</small>	ΔB (bar) <small>0.20-0.80</small>	Δmm ⁽¹⁾	Membrane Aspect ⁽²⁾
CUSTOMER ⁽³²⁾		Start			
JOB ⁽³²⁾		Z_E= ⁽³⁾			
SITE ⁽³²⁾		Z_E=			
REMARK ⁽³²⁾		Z_E=			
TEST NAME ⁽¹²⁾	DATE ⁽²⁰⁾		⁽¹⁾ Coaxiality error (L square)		
Absol. elev.(optional) _____ m		Z _{water} (necess.) _____ m or <input type="checkbox"/> > Z _{final}		⁽²⁾ Elastic, overinflated, wrinkled, snapping, scratched, etc.	
Zero of gauge _____ bar		γ _{top} _____ t/m ³ (default 1.75)		⁽³⁾ Depth reached from extracted blade	
<input type="checkbox"/> Rig	<input type="checkbox"/> Penetrometer	TEST STOPPED BECAUSE →		<input type="checkbox"/> REFUSAL MEMBRANE †	<input type="checkbox"/> OPERATOR
Diameter of rod behind the blade _____		Z = Z _{prefixed}		<input type="checkbox"/>	_____

0	A	B	C	6				12				18				24			
2				2				2				2				2			
4				4				4				4				4			
6				6				6				6				6			
8				8				8				8				8			
1				7				13				19				25			
2				2				2				2				2			
4				4				4				4				4			
6				6				6				6				6			
8				8				8				8				8			
2				8				14				20				26			
2				2				2				2				2			
4				4				4				4				4			
6				6				6				6				6			
8				8				8				8				8			
3				9				15				21				27			
2				2				2				2				2			
4				4				4				4				4			
6				6				6				6				6			
8				8				8				8				8			
4				10				16				22				28			
2				2				2				2				2			
4				4				4				4				4			
6				6				6				6				6			
8				8				8				8				8			
5				11				17				23				29			
2				2				2				2				2			
4				4				4				4				4			
6				6				6				6				6			
8				8				8				8				8			

Fig. 13. Typical DMT field data form - (1 bar = 100 kPa)

Sharpness of electrical signal

Using the syringe (in the calibration configuration) apply 10 or more cycles of vacuum-pressure to verify sharpness of the electrical signal at the *off* and *on* inversions. If the signal inversions are not sharp, the likely reason is dirt between the contacts and the blade must be disassembled and cleaned.

Airtightness

Submerge the blades under water and pressurize them at 0.5 MPa.

Elevations of sensing disc, feeler and quartz (once plexiglas) cylinder

These checks are executed using a special "tripod" dial gage (Fig. 14). The legs of the tripod rest on the surrounding plane and the dial gage permits to measure the elevations above this plane. Their values should fall within the following tolerances:

Sensing disc - Nominal elevation above the surrounding plane: 0.05 mm. Tolerance range: 0.04-0.07 mm.

Feeler - Nominal elevation above the sensing disc: 0.05 mm. Tolerance range: 0.04-0.07 mm.

Quartz cylinder - Only calibrated quartz (once plexiglas) cylinders (height 3.90 ± 0.01 mm) should be used to insure accuracy of the prefixed movement. Therefore checking the elevation of the top of the quartz cylinder is redundant. However such elevation can be checked, and should be in the range 1.13-1.18 mm above the membrane support plane.

Sensing disc extraction force (the sensing disc must be stationary inside the insulating seat)

The disc should fit tightly, thanks to the lateral gripping force, inside the insulating seat. The extraction force should be, as a minimum, equal to the weight of the blade so that, if the sensing disc is lifted, the blade is lifted too without falling.

If the coupling becomes loose (disc free to move) then the gripping force should be increased. One quick fix can be the insertion, while reinstalling the disc, of a small piece of plastic sheet laterally (not on the bottom).

Conditions of the penetration edge of the blade

In case of severe denting of blade's edge, straighten the major undulations, then sharpen the edge using a file.

Coaxiality between blade and axis of the rods

With the *lower adaptor* mounted on the blade, place the inside edge of an L-square against the side of the adaptor. Note the distance from the penetration edge of the blade to the side of the L-square. Turn the



Fig. 14. "Tripod" dial gage

blade 180° and repeat the measurement. The difference between the two distances should not exceed 3 mm (corresponding to a coaxiality error of 1.5 mm).

Blade planarity

Place a 15 cm ruler against the face of the blade parallel to its long side. The "sag" between the ruler and blade should not exceed 0.5 mm (to be checked with a flat 0.5 mm feeler gage).

Check the blade for electrical continuity

If the calibration has been carried out without irregularities in the expected electrical signal, the calibration itself already proves that the electrical function of the blade is working properly.

Additional electrical checks can be carried out with the membrane removed (but with the quartz cylinder in its place) using a continuity tester. The open blade should respond electrically as follows:

- Continuity between the metal tubelet located in the blade neck and the sensing disc
- Continuity between the above metal tubelet and the blade body when the quartz cylinder is lifted
- No continuity (insulation) between the metal tubelet and blade body if the quartz cylinder is depressed (continuity in this case would mean that the blade is in short circuit).

A recommended check just before mounting the membrane is the following:

- Press 10 times or more on the quartz cylinder to insure that the *on* and *off* signal inversions are sharp and prompt.

Sensing disc, underlying cavity and elements inside cavity must be perfectly clean

The parts of the instrument inside the membrane (disc, spring, metal cylinder, cylinder housing) must be kept perfectly clean (e.g. blowing each piece with compressed air) to insure proper electrical contacts.

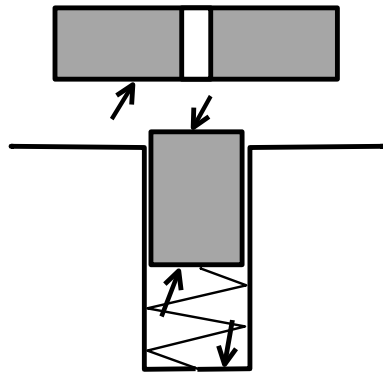

Fig. 15. Electrical contact points to be kept clean to avoid membrane overinflation

A complete guide for disassembling and cleaning the blade can be found in Marchetti & Crapps (1981) and Schmertmann (1988).

In particular, the critical electrical contact points (highlighted in Fig. 15) should be perfectly free from dirt/grains/tissue. If not, the defective electrical contact may cause *severe and costly inconveniences*.

In fact electrical malfunctioning will result in no *B*-signal. In absence of *B*-signal, the operator will keep inflating, eventually overexpanding the membrane beyond ΔA , ΔB tolerances, in which case the test results will be rejected.

The risk of absence of *B*-reading can be reduced by the following check: before starting a sounding, repeat the calibration (ΔA , ΔB) 10 times or more, to make sure that the *B*-signal is regular and sharp.

7.1.2 Control unit

Check the control unit for electrical operation

- Press the test button with the audio switch *on*. The galvanometer and buzzer should activate.
- Connect with an electric wire the inside of the "ground" jack with the female quick connector marked "dilatometer". The galvanometer and buzzer should activate.

Check the control unit for gas leakage

This check is carried out on the control unit alone (cables and blade disconnected). Close the *vent* valves, open the *main valve* and the *micrometer flow valve*. Pressurize the control unit to the maximum gage range. Close the *main valve* to avoid further pressure supply. Observe the gages for leaks.

7.1.3 Pneumatic-electrical cables

Check the cables for mechanical integrity

Inspect the entire length to determine if the tubing is pinched or broken.

Check the cables for electrical operation

Check by a continuity tester both electrical continuity and electrical insulation between the terminals and

the inner wire. The male quick connectors should be in contact with the inner wire, while the metal terminals should be insulated from the wire.

Check the cables for gas leakage

Plug with the special female closed-ended terminal the blade terminal of the cable and connect the other end of the cable to the control unit. Use the control unit to pressurize the cable to 4-6 MPa. Then close the *micrometer flow valve*. Observe the gage for any loss in pressure. A leak can be localized by immersing the cable and fittings in water.

7.2 CHECKS ON TEST EXECUTION

- Verify that *A* is reached in ≈ 15 seconds (within 20 seconds), *B* in ≈ 15 seconds (within 20 seconds) after *A*.
- The change of ΔA or ΔB before/after the sounding must not exceed 25 kPa, otherwise the test will be rejected.
- The *C*-reading, when taken, should be obtained in 45 to 60 seconds after starting the deflation following *B*.

NOTE: Accuracy of DMT measurements

The prefixed displacement is the difference between the height of the quartz (once plexiglas) cylinder and the thickness of the sensing disc. These components are machined to 0.01 mm tolerance, and their dimensions cannot be altered by the operator. Likely change in dimensions of such components due to even large temperature variation is much less than 0.01 mm. Hence the displacement will be $1.10 \text{ mm} \pm 0.02 \text{ mm}$.

The pressure measurements are balance of zero measurements (null method), providing high accuracy. The accuracy of the pressure measurements is the accuracy of the gages in the control unit.

Since the accuracy of both measured pressure and displacement is high, the instrumental accuracy of the DMT results is also high, and operator independent. Accuracy problems can only arise when the following two circumstances occur simultaneously: (a) The soil is very soft. (b) The operator has badly overinflated the membrane, making ΔA , ΔB uncertain.

NOTE: Reproducibility of DMT results

The high reproducibility of the test results is a characteristic of the DMT unanimously observed by many investigators.

It has been noted that "peaks" or other discontinuities in the profiles repeat systematically if one performs more than one sounding, therefore they are not due to a random instrumental deviation, but reflect soil variability.

Even in sand, which is usually considered inherently variable, the DMT has been found to give repeatable profiles.

NOTE: Automatic data acquisition for DMT and "research" dilatometers

While the mechanical DMT is the type most commonly used today, various users have developed automatic data acquisition systems. These systems are outside the scope of this report. Only a few comments are given below.

Automatic data acquisition is not as indispensable as in other in situ tests (e.g. CPT/CPTU), since the DMT generates only a few measurements per minute, that the operator can easily write in the dead time between the operations.

Automatic acquisition does not speed the test or increase productivity or accuracy. Rather, automatic recording is often requested nowadays mostly for *quality control checks*, easier when everything is recorded.

"Research" dilatometers, involving blades instrumented with various types of sensors, are outside the scope of this report. The interested reader is referred to Boghrat (1987), Campanella & Robertson (1991), Fretti et al. (1992), Huang et al. (1991), Kagawa et al. (1995), Lutenecker & Kabir (1988), Mayne & Martin (1998).

One interesting finding obtained by testing with different instrumented blades is that the pressure-displacement relationship, between A and B , is almost linear.

8. DISSIPATION TESTS

In low permeability soils (clays, silts) the excess pore water pressure induced by the blade penetration dissipates over a period of time much longer than required for the DMT test. In these soils it is possible to estimate the in situ consolidation/flow parameters by means of dissipation tests.

A DMT dissipation test consists in stopping the blade at a given depth, then monitoring the decay of the total contact horizontal stress σ_h with time. The flow parameters are then inferred from the rate of decay.

The DMT dissipation method recommended by the authors is the DMT-A method (Marchetti & Totani 1989, ASTM 2001). Other available methods are the DMT-C method (Robertson et al. 1988) and the DMT-A₂ method (ASTM 2001). The interpretation is covered in Section 11.4.1.

Dissipation tests are generally performed during the execution of a standard DMT sounding, stopping the blade at the desired dissipation depth. After the

dissipation is completed, the sounding is resumed following the current test procedure. In this case, the time required for the entire DMT sounding includes the time for the dissipations.

Dissipation tests can be time consuming and are generally performed only when information on flow properties is especially valuable. In very low permeability clays, a dissipation can last 24 hours or more. In more permeable silty layers, the dissipation may last hours, if not minutes.

Dissipation tests can also be performed separated from DMT soundings, by means of one or more blades pushed and left in place at the desired depths. This permits to carry out DMT soundings and dissipations simultaneously, with considerable time saving.

The dissipation depths are decided in advance, based on earlier DMT profiles or other available soil information.

It should be noted that DMT dissipations are not feasible in relatively permeable soils (e.g. silty sands), whose permeability is such that most of the dissipation occurs in the first minute. Hence most of the dissipation curve is missed, because the first reading cannot be taken in less than 10-15 seconds from start. Clearly DMT dissipations are not feasible in sand and gravel.

8.1 DMT-A DISSIPATION METHOD

The DMT-A method (Marchetti & Totani 1989) consists in stopping the blade at a given depth, then taking a timed sequence of A -readings. Note that only the A -reading is taken, avoiding the expansion to B . The operator deflates the membrane by opening the *toggle vent valve* as soon as A is reached (this method is also called " A & deflate" dissipation).

Procedure:

- 1) Stop the penetration at the desired dissipation depth and immediately start a stopwatch. The time origin ($t = 0$) is the instant at which pushing is stopped. Then, without delay, *slowly* inflate the membrane to take the A -reading. As soon as A is reached, immediately vent the blade. Read at the stopwatch the elapsed time at the instant of the A -reading and record it together with the A -value.
- 2) Continue to take additional A -readings to obtain reasonably spaced points for the time-dissipation curve. A factor of 2 increase in time at each A -reading is satisfactory (e.g. 0.5, 1, 2, 4, 8, 15, 30 etc. minutes after stopping the blade). For each A -reading record the exact stopwatch time (which has not necessarily to coincide with the above values).

3) Plot in the field a preliminary $A-\log t$ diagram. Such diagram has usually an S-shape. The dissipation can be stopped when the $A-\log t$ curve has flattened sufficiently so that the contraflexure point is clearly identified (the time at the contraflexure point t_{flex} is used for the interpretation).

8.2 DMT-A₂ DISSIPATION METHOD

The DMT-A₂ method (described in ASTM 2001) is an evolution of the DMT-C method (Robertson et al. 1988, see also details in Schmertmann 1988 and US DOT 1992).

The DMT-C method consists in performing, at different times, one cycle of readings $A-B-C$ and plotting the decay curve of the C -readings taken at the end of each cycle.

The DMT-C method relies on the assumption that p_2 (corrected C -reading) is approximately equal to the pore pressure u in the soil facing the membrane. Then the method treats the p_2 vs time curve as the decay curve of u (hence p_2 after complete dissipation should be equal to u_0).

The assumption $p_2 = u$ has been found to be generally valid for soft clays, not valid for OC clays. Thus the DMT-C method should be used with caution.

In 1991 (DMT Digest 12) Schmertmann found that a better approximation of the u decay can be obtained in the following way. Perform first one complete cycle $A-B-C$ (only one cycle), then take only A -readings (called by Schmertmann " A_2 ") at different times, without performing further $A-B-C$ cycles.

The procedure for DMT-A₂ is very similar to the one previously described for the DMT-A dissipation, with the following differences:

- 1) The readings taken and used to construct the decay curve are the A_2 -readings rather than the A -readings.
- 2) The dissipation is stopped after making at least enough measurements to find t_{50} (time at 50 % of A -dissipation). If time permits, the test is continued long enough for the dissipation curve to approach its eventual asymptote at 100 % dissipation A_{100} . Ideally $A_{100} = u_0$ when corrected.

PART B

INTERPRETATION AND APPLICATIONS

9. DATA REDUCTION AND INTERPRETATION

9.1 INTERPRETATION IN TERMS OF SOIL PARAMETERS

The primary way of using DMT results is to interpret them in terms of common soil parameters.

The parameters estimated by DMT can be compared and checked vs the parameters obtained by other tests, and design profiles can be selected. This methodology ("design via parameters") is the current practice in engineering applications.

"Direct" DMT-based methods are limited to some specific applications (e.g. axially loaded piles, P - y curves for laterally loaded piles).

9.2 DATA REDUCTION / INTERMEDIATE AND COMMON SOIL PARAMETERS

The basic DMT data reduction formulae and correlations are summarized in Table 1.

Field readings A , B are corrected for membrane stiffness, gage zero offset and feeler pin elevation in order to determine the pressures p_0 , p_1 using the following formulae:

$$p_0 = 1.05 (A - Z_M + \Delta A) - 0.05 (B - Z_M - \Delta B) \quad (1)$$

$$p_1 = B - Z_M - \Delta B \quad (2)$$

where

ΔA , ΔB = corrections determined by membrane calibration

Z_M = gage zero offset (gage reading when vented to atmospheric pressure) – For a correct choice of Z_M see Note on next page.

The corrected pressures p_0 and p_1 are subsequently used in place of A and B in the interpretation.

The original correlations (Marchetti 1980) were obtained by calibrating DMT results versus high quality parameters obtained by traditional methods. Many of these correlations form the basis of today interpretation, having been generally confirmed by subsequent research.

The interpretation evolved by first identifying three "intermediate" DMT parameters (Marchetti 1980):

- the material index I_D
- the horizontal stress index K_D
- the dilatometer modulus E_D

then relating these intermediate parameters (not directly p_0 and p_1) to common soil parameters.

SYMBOL	DESCRIPTION	BASIC DMT REDUCTION FORMULAE	
p_0	Corrected First Reading	$p_0 = 1.05 (A - Z_M + \Delta A) - 0.05 (B - Z_M - \Delta B)$	$Z_M =$ Gage reading when vented to atm. If ΔA & ΔB are measured with the same gage used for current readings A & B, set $Z_M = 0$ (Z_M is compensated)
p_1	Corrected Second Reading	$p_1 = B - Z_M - \Delta B$	
I_D	Material Index	$I_D = (p_1 - p_0) / (p_0 - u_0)$	$u_0 =$ pre-insertion pore pressure
K_D	Horizontal Stress Index	$K_D = (p_0 - u_0) / \sigma'_{v0}$	$\sigma'_{v0} =$ pre-insertion overburden stress
E_D	Dilatometer Modulus	$E_D = 34.7 (p_1 - p_0)$	E_D is NOT a Young's modulus E . E_D should be used only AFTER combining it with K_D (Stress History). First obtain $M_{DMT} = R_M E_D$, then e.g. $E \approx 0.8 M_{DMT}$
K_0	Coeff. Earth Pressure in Situ	$K_{0,DMT} = (K_D / 1.5)^{0.47} - 0.6$	for $I_D < 1.2$
OCR	Overconsolidation Ratio	$OCR_{DMT} = (0.5 K_D)^{1.56}$	for $I_D < 1.2$
c_u	Undrained Shear Strength	$c_{u,DMT} = 0.22 \sigma'_{v0} (0.5 K_D)^{1.25}$	for $I_D < 1.2$
Φ	Friction Angle	$\Phi_{safe,DMT} = 28^\circ + 14.6^\circ \log K_D - 2.1^\circ \log^2 K_D$	for $I_D > 1.8$
c_h	Coefficient of Consolidation	$c_{h,DMTA} \approx 7 \text{ cm}^2 / t_{flex}$	t_{flex} from A-log t DMT-A decay curve
k_h	Coefficient of Permeability	$k_h = c_h \gamma_w / M_h$ ($M_h \approx K_0 M_{DMT}$)	
γ	Unit Weight and Description	(see chart in Fig. 16)	
M	Vertical Drained Constrained Modulus	$M_{DMT} = R_M E_D$ if $I_D \leq 0.6$ $R_M = 0.14 + 2.36 \log K_D$ if $I_D \geq 3$ $R_M = 0.5 + 2 \log K_D$ if $0.6 < I_D < 3$ $R_M = R_{M,0} + (2.5 - R_{M,0}) \log K_D$ with $R_{M,0} = 0.14 + 0.15 (I_D - 0.6)$ if $K_D > 10$ $R_M = 0.32 + 2.18 \log K_D$ if $R_M < 0.85$ set $R_M = 0.85$	
u_0	Equilibrium Pore Pressure	$u_0 = p_2 = C - Z_M + \Delta A$	In free-draining soils

Table 1. Basic DMT reduction formulae

The intermediate parameters I_D , K_D , E_D are "objective" parameters, calculated from p_0 and p_1 using the formulae shown in Table 1.

The interpreted (final) parameters are common soil parameters, derived from the intermediate parameters I_D , K_D , E_D using the correlations shown in Table 1 (or other established correlations).

The values of the in situ equilibrium pore pressure u_0 and of the vertical effective stress σ'_{v0} prior to blade insertion must also be introduced into the formulae and have to be known, at least approximately.

Parameters for which the DMT provides an interpretation (see Table 1) are:

- vertical drained constrained modulus M (all soils)
- undrained shear strength c_u (in clay)
- in situ coefficient of lateral earth pressure K_0 (in clay)
- overconsolidation ratio OCR (in clay)
- horizontal coefficient of consolidation c_h (in clay)
- coefficient of permeability k_h (in clay)
- friction angle ϕ (in sand)
- unit weight γ and soil type (all soils)
- equilibrium pore pressure u_0 (in sand).

Correlations for clay apply for $I_D < 1.2$. Correlations for sand apply for $I_D > 1.8$.

The constrained modulus M and the undrained shear strength c_u are believed to be the most reliable and useful parameters obtained by DMT.

NOTE: Gage zero offset Z_M

In all the formulae containing Z_M enter $Z_M = 0$ (even if $Z_M \neq 0$) if ΔA , ΔB are measured by the *same gage* used for the current A , B readings (this is the normal case today, using the dual-gage control unit).

The reason is that the Z_M correction is already accounted for in ΔA , ΔB (this compensation can be verified readily from the algebra of the correction formulae for A , B). Hence entering the real Z_M would result, incorrectly, in applying twice the correction to A , B .

In general, if ΔA , ΔB and the current A , B readings are not measured by the same gage, the value of Z_M to be input in the equations should be the zero offset of the gage used for reading A & B minus the zero offset of the gage used for reading ΔA & ΔB .

NOTE: Correction formula for p_0

Eq. 1 for p_0 (back-extrapolated contact pressure at zero displacement) derives from the assumption of a linear pressure-displacement relationship between 0.05 mm (elevation of the feeler pin above sensing disc) and 1.10 mm (Marchetti & Crapps 1981).

NOTE: Sign of ΔA , ΔB corrections

Although the actual ΔA -pressure is negative (vacuum), it simulates a positive soil pressure. Consequently it is recorded and introduced in the p_0 formula as a positive number when it is a vacuum (which is the normal case). Eq. 1 is already adjusted to take into account that a positive ΔA is a vacuum. ΔB is normally positive.

NOTE: Selecting the "average" ΔA , ΔB to calculate p_0 , p_1 (for a detailed treatment of this topic see Marchetti 1999)

Selecting the average ΔA , ΔB from the before/after ΔA , ΔB values must be done by an experienced technician. While performing the average, the entity of ΔA , ΔB and their variations during the sounding will also give him an idea of the care exercised during the execution.

If the test has been regular (e.g. the membrane has not been overinflated, and the Eurocode 7 tolerances for ΔA , ΔB have not been exceeded), the before/after values of ΔA , ΔB are very close, so that their arithmetic average is adequate.

If ΔA or ΔB vary more than 25 kPa during a sounding, the results, according to the Eurocode 7 (1997), should be discarded. However, if the soil is stiff, the results are not substantially influenced by ΔA , ΔB , and using typical ΔA , ΔB values (e.g. 15 and 40 kPa respectively) generally leads to acceptable results.

NOTE: Comments on the 3 intermediate parameters

The three intermediate parameters I_D , K_D , E_D are derived from two field readings. Clearly, only two of them are independent (the DMT is a two-parameter test). I_D , K_D , E_D have been introduced because each one of them has some recognizable physical meaning and some engineering usefulness.

10. INTERMEDIATE DMT PARAMETERS

10.1 MATERIAL INDEX I_D (SOIL TYPE)

The material index I_D is defined as follows:

$$I_D = \frac{p_1 - p_0}{p_0 - u_0} \quad (3)$$

where u_0 is the pre-insertion in situ pore pressure.

The above definition of I_D was introduced having observed that the p_0 and p_1 profiles are systematically "close" to each other in clay and "distant" in sand.

According to Marchetti (1980), the soil type can be identified as follows:

clay	$0.1 < I_D < 0.6$
silt	$0.6 < I_D < 1.8$

$$\text{sand} \quad 1.8 < I_D < (10)$$

In general, I_D provides an expressive profile of soil type, and, in "normal" soils, a reasonable soil description. Note that I_D sometimes misdescribes silt as clay and vice versa, and of course a mixture clay-sand would generally be described by I_D as silt.

When using I_D , it should be kept in mind that I_D is not, of course, the result of a sieve analysis, but a parameter reflecting mechanical behavior (some kind of "rigidity index"). For example, if a clay for some reasons behaves "more rigidly" than most clays, such clay will be probably interpreted by I_D as silt.

Indeed, if one is interested in mechanical behavior, sometimes it could be more useful for his application a description based on a mechanical response rather than on the real grain size distribution. If, on the other hand, the interest is on permeability, then I_D should be helpfully supplemented by the pore pressure index U_D (see Section 11.4.4).

10.2 HORIZONTAL STRESS INDEX K_D

The horizontal stress index K_D is defined as follows:

$$K_D = \frac{p_0 - u_0}{\sigma'_{v0}} \quad (4)$$

where σ'_{v0} is the pre-insertion in situ overburden stress.

K_D provides the basis for several soil parameter correlations and is a key result of the dilatometer test.

The horizontal stress index K_D can be regarded as K_0 amplified by the penetration. In genuinely NC clays (no aging, structure, cementation) the value of K_D is $K_{D,NC} \approx 2$.

The K_D profile is similar in shape to the OCR profile, hence generally helpful for "understanding" the soil deposit and its stress history (Marchetti 1980, Jamiolkowski et al. 1988).

10.3 DILATOMETER MODULUS E_D

The dilatometer modulus E_D is obtained from p_0 and p_1 by the theory of elasticity (Gravesen 1960). For the 60 mm diameter of the membrane and the 1.1 mm displacement it is found:

$$E_D = 34.7 (p_1 - p_0) \quad (5)$$

E_D in general should not be used as such, especially because it lacks information on stress history. E_D should be used only in combination with K_D and I_D .

The symbol E_D should not evoke special affinity with the Young's modulus E' (see Section 11.3.2).

11. DERIVATION OF GEOTECHNICAL PARAMETERS

11.1 STRESS HISTORY / STATE PARAMETERS

11.1.1 Unit weight γ and soil type

A chart for determining the soil type and unit weight γ (normalized to $\gamma_w = \gamma$ water) - Marchetti & Crapps 1981 - (1 bar = 100 kPa)

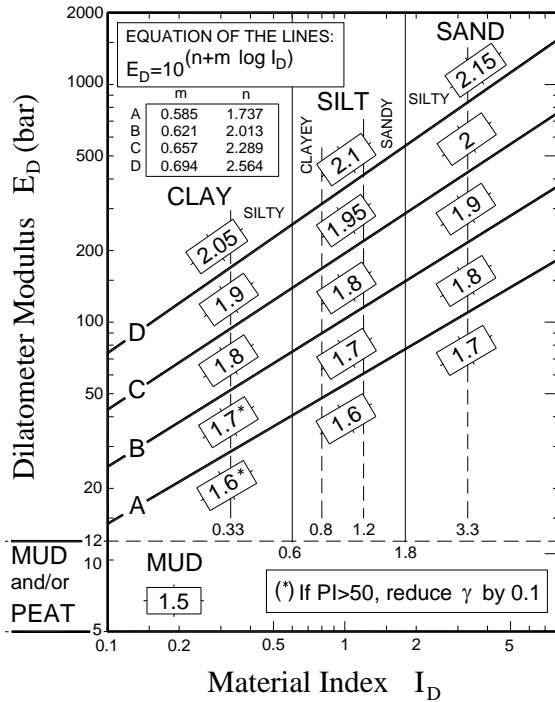

Fig. 16. Chart for estimating soil type and unit weight γ (normalized to $\gamma_w = \gamma$ water) - Marchetti & Crapps 1981 - (1 bar = 100 kPa)

γ from I_D and E_D was developed by Marchetti & Crapps 1981 (Fig. 16).

Many Authors (e.g. Lacasse & Lunne 1988) have presented modified forms of such table, more closely matching local conditions. However the original chart is generally a good average for "normal" soils. On the other hand, the main scope of the chart is not the accurate estimation of γ , but the possibility of constructing an approximate profile of σ'_{v0} , needed in the elaboration.

11.1.2 Overconsolidation ratio OCR

11.1.2.1 OCR in clay

The original correlation for deriving the overconsolidation ratio OCR from the horizontal stress index K_D (based on data only for uncemented clays) was proposed by Marchetti (1980) from the observation of the similarity between the K_D profile and the OCR profile:

$$OCR_{DMT} = (0.5 K_D)^{1.56} \quad (6)$$

Eq. 6 has built-in the correspondence $K_D = 2$ for $OCR = 1$ (i.e. $K_{D,NC} \approx 2$). This correspondence has been confirmed in many genuinely NC (no cementation, aging, structure) clay deposits.

The resemblance of the K_D profile to the OCR profile has also been confirmed by many subsequent comparisons (e.g. Jamiolkowski et al. 1988).

Research by Powell & Uglow (1988) on the $OCR-K_D$ correlation in several UK deposits showed some deviation from the original correlation. However their research indicated that:

- The original correlation line (Eq. 6) is intermediate between the UK datapoints.
- The datapoints relative to each UK site were in a remarkably narrow band, parallel to the original correlation line.
- The narrowness of the datapoints band for each site is a confirmation of the remarkable resemblance of the OCR and K_D profiles, and the parallelism of the datapoints for each site to the original line is a confirmation of its slope.

The original $OCR-K_D$ correlation for clay was also confirmed by a comprehensive collection of data by Kamei & Iwasaki 1995 (Fig. 17), and, theoretically, by Finno 1993 (Fig. 18).

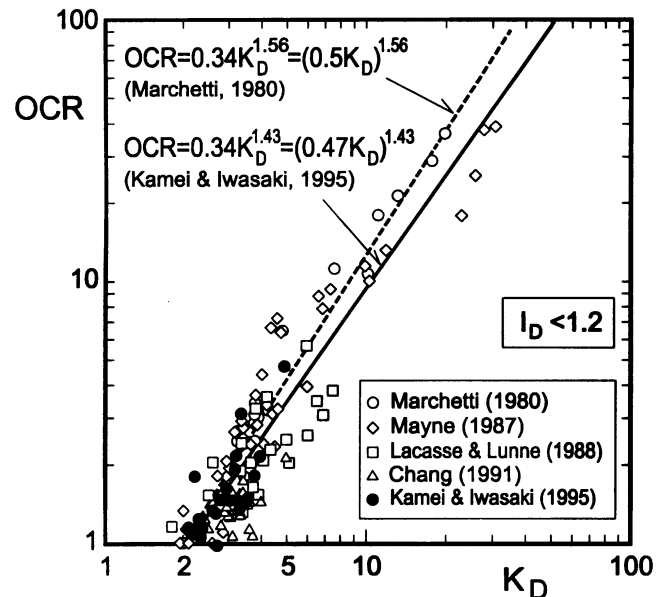

Fig. 17. Correlation K_D -OCR for cohesive soils from various geographical areas (Kamei & Iwasaki 1995)

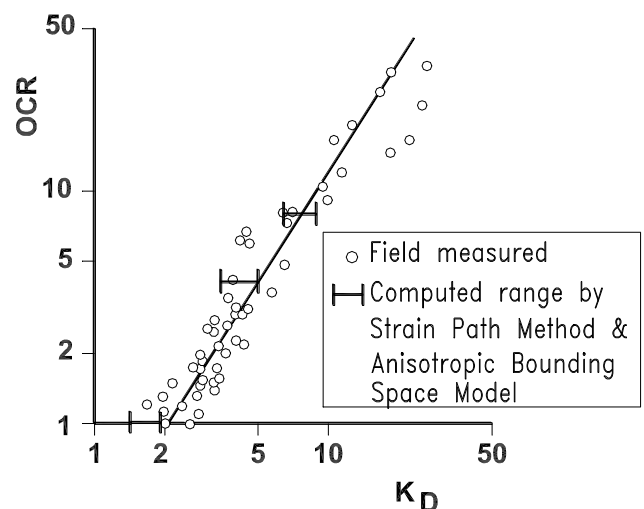

Fig. 18. Theoretical K_D vs OCR (Finno 1993)

A confirmation of $K_D \approx 2$ in genuine NC clays comes from recent slip surface research (Totani et al. 1997). In fact: (a) In all the layers where sliding was confirmed by inclinometers, it was found $K_D \approx 2$. (b) The clay in the remolded sliding band has certainly lost any trace of aging, structure, cementation, i.e. such clay is a good example of genuine NC clay.

Thus $K_D \approx 2$ appears the lower bound value for $K_{D,NC}$. If a geologically NC clay has $K_D > 2$, any excess of K_D above 2 indicates the likely existence of aging, structure or cementation.

Cemented-aged-structured clays (for brevity called below "cemented clays")

The original $OCR-K_D$ correlation for uncemented clays established by Marchetti (1980) was presented as non applicable to cemented clays. However various researchers have attempted to develop correlations also in cemented clays.

It cannot be expected the existence of a unique $OCR-K_D$ correlation valid for all cemented clays, because the deviation from the uncemented correlation depends on the (variable) entity of the cementation and the consequent (variable) excess of K_D above 2. Therefore, in general, datapoints for cemented clays should be kept separated, without attempting to establish a unique average correlation for both cemented and uncemented clays.

Practical indications for estimating OCR in various clays

- The original $OCR-K_D$ correlation (Eq. 6) is a good base for getting a first interpretation of the OCR profile (or, at least, generally accurate information on its shape).
- In general the K_D profile is helpful for "understanding" the stress history. The K_D profile permits to discern NC from OC clays, and clearly identifies shallow or buried desiccation crusts. The K_D profile is often the first diagram that the engineer inspects, because from it he can get at a glance a general grasp on the stress history.
- In NC clays, the inspection of the K_D profile permits to distinguish genuine NC clays ($K_D \approx 2$, constant with depth) from cemented NC clays ($K_D \approx 3$ to 4, constant with depth, e.g. Fucino, Onsøy). In these clays any excess of K_D compared with the "floor" value $K_D \approx 2$ provides an indication of the intensity of cementation/structure/aging. However the NC condition can be easily recognized (despite $K_D > 2$), because K_D does not decrease with depth as typical in OC deposits.
- In cemented OC clays the inspection of the K_D profile does not reveal cementation as clearly as in

NC clays (though the cementation shows up in the form of a less marked decrease of K_D with depth). In cemented clays the geological OCR will be overpredicted by Eq. 6.

- Highly accurate and detailed profiles of the in situ OCR can be obtained by calibrating OCR_{DMT} versus a few high quality oedometers (in theory even one or two - see Powell & Uglow 1988). Since OCR is a parameter difficult and costly to obtain, for which there are not many measuring options, the possibility of projecting via K_D a large number of high quality data appears useful.
- Stiff fissured OC clays. It is found that in non fissured OC clays the K_D profiles are rather smooth, while in fissured OC clays the K_D profiles are markedly seesaw-shaped. Such difference indicates that fissures are, to some extent, identified by the low points in the K_D profiles. The sensitivity of K_D to fissures may be useful in studies of fissure pattern. Note that the K_D s in the fissures of an OC clay are still considerably > 2 , in fact fissures are not, in general, slip surfaces - characterized by $K_D = 2$ (see Section 13.4).

11.1.2.2 OCR in sand

The determination (even the definition) of OCR in sand is more difficult than in clay. OCR in sand is often the result of a complex history of preloading or desiccation or other effects. Moreover, while OCR in clay can be determined by oedometers, sample disturbance does not permit the same in sand. Therefore some approximation must be accepted.

A way of getting some information on OCR in sand is to use the ratio M_{DMT}/q_c . The basis is the following:

- Jendebly (1992) performed DMTs and CPTs before and after compaction of a loose sand fill. He found that before compaction (i.e. in nearly NC sand) the ratio M_{DMT}/q_c was 7-10, after compaction (i.e. in OC sand) 12-24.
- Calibration chamber (CC) research (Baldi et al. 1988) comparing q_c with M , both measured on the CC specimen, found the following ratios M_{cc}/q_c : in NC sands 4-7, in OC sands 12-16.
- Additional data in sands from instrumented embankments and screw plate tests (Jamiolkowski 1995) indicated a ratio (in this case E'/q_c): in NC sands 3-8, in OC sands 10-20.
- The well documented finding that compaction effects are felt more sensitively by M_{DMT} than by q_c (see Section 13.5) also implies that M_{DMT}/q_c is increased by compaction/precompression (see Fig. 42 ahead).

Hence OCR in sands can be approximately evaluated from the ratio M_{DMT}/q_c , using the following indicative values as a reference: $M_{DMT}/q_c = 5-10$ in NC sands, $M_{DMT}/q_c = 12-24$ in OC sands.

An independent indication of some ability of K_D to reflect OCR in sand comes from the crust-like K_D profiles often found at the top of sand deposits, very similar to the typical K_D profiles found in OC desiccation crusts in clay.

11.1.3 In situ coefficient of lateral earth pressure K_0

11.1.3.1 K_0 in clay

The original correlation for K_0 , relative to uncemented clays (Marchetti 1980), is:

$$K_0 = (K_D / 1.5)^{0.47} - 0.6 \quad (7)$$

Various Authors (e.g. Lacasse & Lunne 1988, Powell & Uglow 1988, Kulhawy & Mayne 1990) have presented slightly modified forms of the above equation. However the original correlation produces estimates of K_0 generally satisfactory, especially considering the inherent difficulty of precisely measuring K_0 and that, in many applications, even an approximate estimate of K_0 may be sufficient.

In highly cemented clays, however, the Eq. 7 may significantly overestimate K_0 , since part of K_D is due to the cementation.

Example comparisons of K_0 determined by DMT and by other methods at two research sites are shown in Fig. 19 (Aversa 1997).

11.1.3.2 K_0 in sand

The original $K_0 - K_D$ correlation was obtained by interpolating datapoints relative mostly to clay. The very few (in 1980) datapoints relative to sands seemed to plot on the same curve. However, subsequent sand datapoints showed that a unique correlation cannot be established, since such correlation in sand also depends on ϕ or D_r .

Schmertmann (1982, 1983), based on CC results, interpolated through the CC datapoints a $K_0 - K_D - \phi$ correlation equation (the lengthy fractionlike equation reported as Eq. 1 in Schmertmann 1983 or Eq. 6.5 in US DOT 1992). Such equation is the analytical equivalent of Fig. 10 in Schmertmann (1983), containing, in place of a unique $K_0 - K_D$ equation, a family of $K_0 - K_D$ curves, one curve for each ϕ . Since ϕ is in general unknown, Schmertmann (1982, 1983) suggested to use also the Durgunoglu & Mitchell (1975) theory, providing an additional condition $q_c - K_0 - \phi$, if q_c (or q_D) is also measured. He suggested an iterative computer procedure (relatively complicated) permitting the determination of both K_0 and ϕ . A detailed description of the method can be

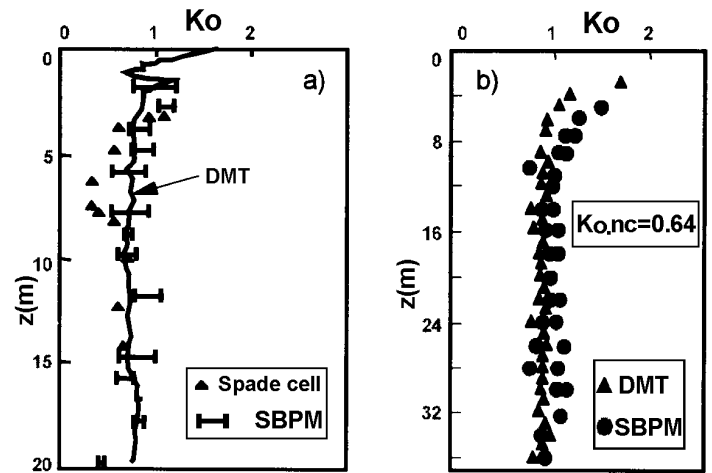

Fig. 19. K_0 from DMT vs K_0 by other methods at two clay research sites (Aversa 1997)

(a) Bothkennar, UK (Nash et al. 1992) (b) Fucino, Italy (Burghignoli et al. 1991)

found in US DOT (1992).

To facilitate calculations, Marchetti (1985) prepared a $K_0 - q_c - K_D$ chart in which ϕ was eliminated, by combining the Schmertmann (1982, 1983) $K_0 - K_D - \phi$ relation with the Durgunoglu & Mitchell (1975) $q_c - K_0 - \phi$ relation. Such chart (reported as Fig. 6.4 in US DOT 1992) provides K_0 , once q_c and K_D are given.

Baldi et al. (1986) updated such $K_0 - q_c - K_D$ chart by incorporating all subsequent CC work. Moreover the chart was converted into simple algebraic equations:

$$K_0 = 0.376 + 0.095 K_D - 0.0017 q_c / \sigma'_{v0} \quad (8)$$

$$K_0 = 0.376 + 0.095 K_D - 0.0046 q_c / \sigma'_{v0} \quad (9)$$

Eq. 8 was determined as the best fit of CC data, obtained on artificial sand, while Eq. 9 was obtained by modifying the last coefficient to predict "correctly" K_0 for the natural Po river sand.

In practice the today recommendation for K_0 in sand is to use the above Eqns. 8 and 9 with the following values of the last coefficient: -0.005 in "seasoned" sand, -0.002 in "freshly deposited" sand (though such choice involves some subjectivity).

While this is one of the few methods available for estimating K_0 in sand (or at least the shape of the K_0 profile), its reliability is difficult to establish, due to scarcity of reference values.

Cases have been reported of satisfactory agreement (Fig. 20, Jamiolkowski 1995). In other cases the K_0 predictions have been found to be incorrect as absolute values, though the shape of the profile appears to reflect the likely K_0 profile. The uncertainty is especially pronounced in cemented sands (expectable, due to the additional unknown

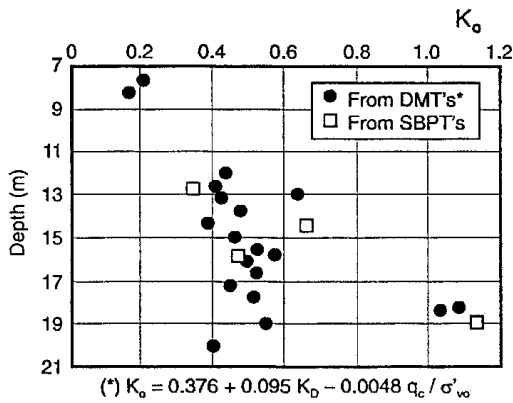

Fig. 20. K_0 from DMTs and SBPTs in natural Ticino sand at Pavia (Jamiolkowski 1995)

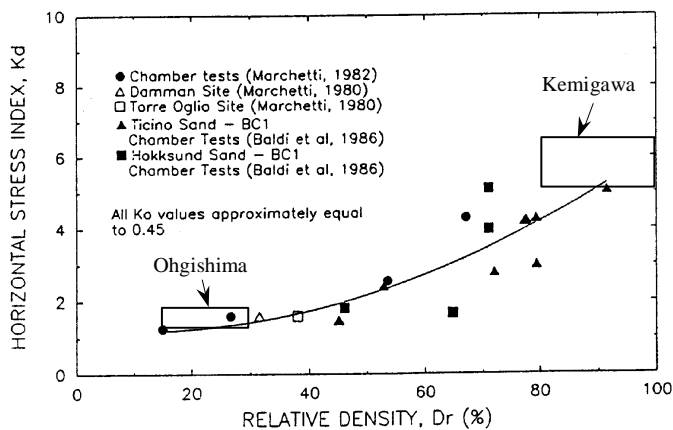

Fig. 21. Correlation $K_D - D_r$ for NC uncemented sands (after Reyna & Chameau 1991, also including Ohgishima and Kemigawa datapoints obtained by Tanaka & Tanaka 1998)

"cementation"). An inconvenience of the method is that it requires both DMT and CPT and proper matching of correspondent K_D and q_c .

11.1.4 Relative density D_r (sand)

In NC uncemented sands, the recommended relative density correlation is the one shown in Fig. 21 (Reyna & Chameau 1991), where D_r is derived from K_D . This correlation is supported by the additional $K_D - D_r$ datapoints (also included in Fig. 21) obtained by Tanaka & Tanaka (1998) at the Ohgishima and Kemigawa sites, where D_r was determined on high quality samples taken by the freezing method.

In OC sands, and in cemented sands, Fig. 21 will overpredict D_r , since part of K_D is due to the overconsolidation and cementation, rather than to D_r . The amount of the overprediction is difficult to evaluate at the moment.

11.2 STRENGTH PARAMETERS

11.2.1 Undrained shear strength c_u

The original correlation for determining c_u from

DMT (Marchetti 1980) is the following:

$$c_u = 0.22 \sigma'_{v0} (0.5 K_D)^{1.25} \quad (10)$$

Eq. 10 has generally been found to be in an intermediate position between subsequent datapoints presented by various researchers (e.g. Lacasse & Lunne 1988, Powell & Uglow 1988). Example comparisons between c_u DMT and c_u by other tests at two research sites are shown in Figs. 22 and 23.

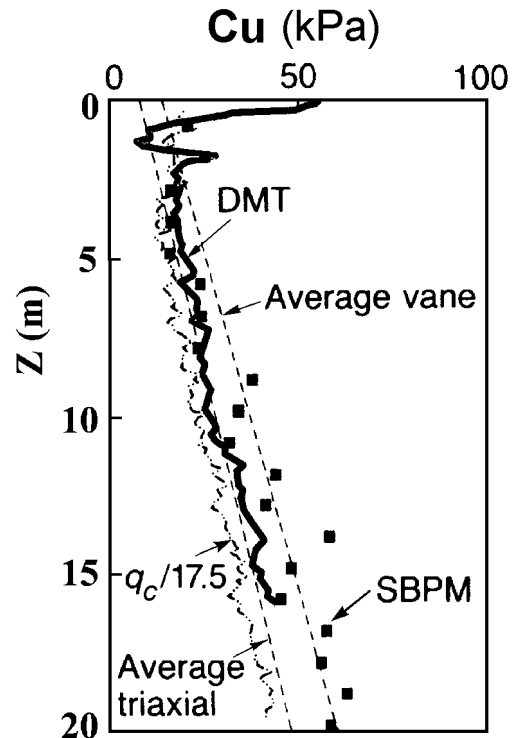

Fig. 22. Comparison between c_u determined by DMT and by other tests at the National Research Site of Bothkennar, UK (Nash et al. 1992)

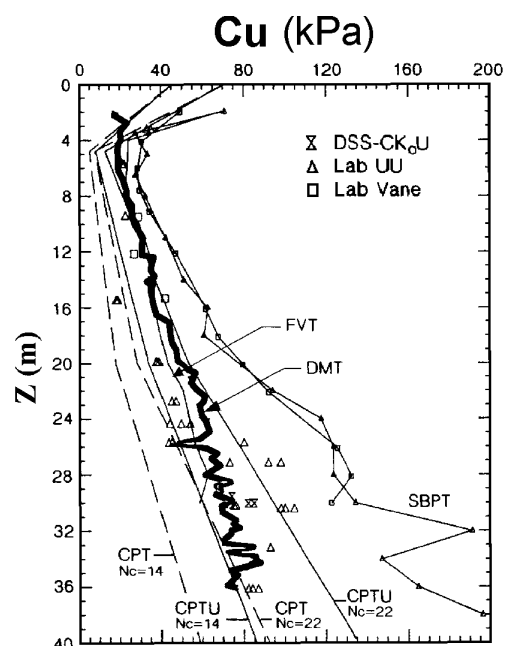

Fig. 23. Comparison between c_u determined by DMT and by other tests at the National Research Site of Fucino, Italy (Burghignoli et al. 1991)

Experience has shown that, in general, $c_{u,DMT}$ is quite accurate and dependable for design, at least for everyday practice.

11.2.2 Friction angle Φ (sand)

Two methods are currently used today for estimating ϕ from DMT (see also Marchetti 1997).

The first method (Method 1) provides simultaneous estimates of ϕ and K_0 derived from the pair K_D and q_D (Method 1a) or from the pair K_D and q_c (Method 1b). The second method (Method 2) provides a *lower bound* estimate of ϕ based only on K_D .

Method 1a (ϕ from K_D, q_D)

This iterative method, developed by Schmertmann (1982, 1983), described in Section 11.1.3.2 relative to K_0 in sand, permits the determination of both K_0 and ϕ .

Method 1b (ϕ from K_D, q_c)

This method (Marchetti 1985) first derives K_0 from q_c and K_D by Eqns. 8 and 9, as indicated in Section 11.1.3.2 (K_0). Then uses the theory of Durgunoglu & Mitchell (1975), or its handy graphical equivalent chart in Fig. 24, to estimate ϕ from K_0 and q_c .

Method 2 (ϕ from K_D)

Details on the derivation of the method can be found in Marchetti (1997). ϕ is obtained from K_D by the following equation:

$$\phi_{safe,DMT} = 28^\circ + 14.6^\circ \log K_D - 2.1^\circ \log^2 K_D \quad (11)$$

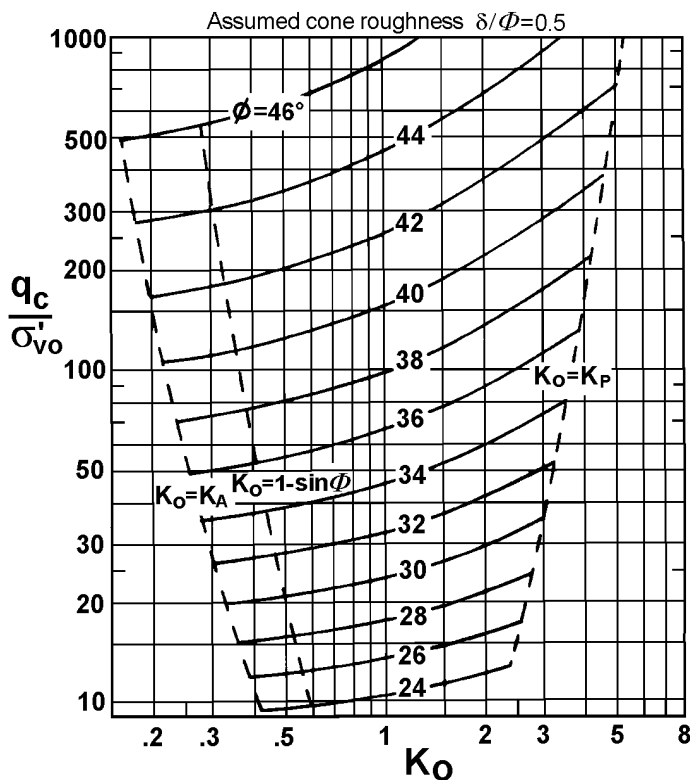

Fig. 24. Chart $q_c - K_0 - \phi$ – graphical equivalent of the Durgunoglu & Mitchell theory (worked out by Marchetti 1985)

As already noted, ϕ from Eq. 11 is intended to be not the "most likely" estimate of ϕ , but a *lower bound* value (typical entity of the underestimation believed to be 2° to 4°). Obviously, if more accurate reliable (higher) values of ϕ are available, then such values should be used.

It should be noted that in cemented sands it is difficult to separate the two strength parameters $c-\phi$, because there is an additional unknown.

11.3 DEFORMATION PARAMETERS

11.3.1 Constrained modulus M

The modulus M determined from DMT (often designated as M_{DMT}) is the vertical drained confined (one-dimensional) tangent modulus at σ'_{v0} and is the same modulus which, when obtained by oedometer, is called $E_{oed} = 1/m_v$.

M_{DMT} is obtained by applying to E_D the correction factor R_M according to the following expression:

$$M_{DMT} = R_M E_D \quad (12)$$

The equations defining $R_M = f(I_D, K_D)$ (Marchetti 1980) are given in Table 1. The value of R_M increases with K_D . I_D has a lesser influence on R_M . Hence R_M is *not* a unique proportionality constant.

R_M varies mostly in the range 1 to 3.

Since E_D is an "uncorrected" modulus, while M_{DMT} is a "corrected" modulus, deformation properties should in general be derived from M_{DMT} and not from E_D .

Experience has shown that M_{DMT} is highly reproducible. In most sites M_{DMT} varies in the range 0.4 to 400 MPa.

Comparisons both in terms of $M_{DMT} - M_{reference}$ and in terms of predicted vs measured settlements have shown that, in general, M_{DMT} is reasonably accurate and dependable for everyday design practice.

M_{DMT} is to be used in the same way as if it was obtained by other methods (say a good quality oedometer) and introduced in one of the available procedures for evaluating settlements.

Example comparisons between M_{DMT} and M from high quality oedometers at two research sites are shown in Figs. 25 and 26.

NOTE: Necessity of applying the correction R_M to E_D
 – E_D is derived by loading the soil distorted by the penetration.

– The direction of loading is horizontal, while M is vertical.

– E_D lacks information on stress history, reflected to some extent by K_D . The necessity of stress history for the realistic assessment of settlements has been emphasized by many researchers (e.g. Leonards &

Frost 1988, Massarsch 1994).

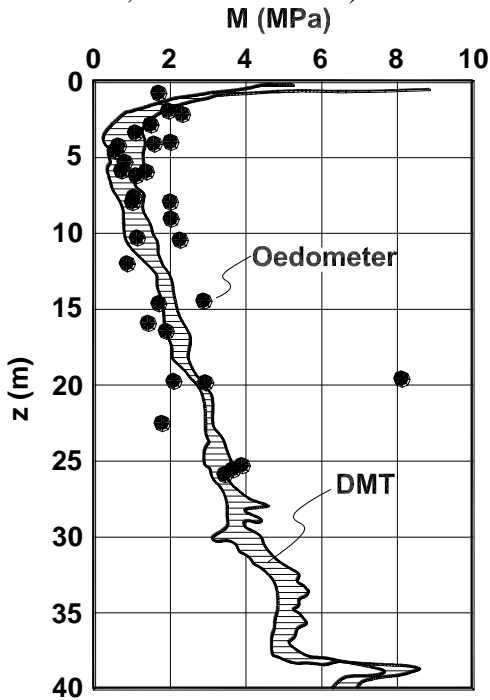

Fig. 25. Comparison between M determined by DMT and by high quality oedometers, Onsøy clay, Norway (Lacasse 1986)

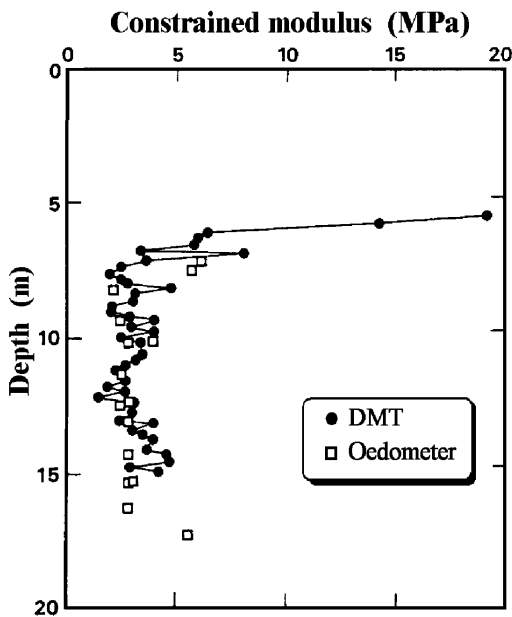

Fig. 26. Comparison between M determined by DMT and by high quality oedometers, Komatsugawa site, Japan (Iwasaki et al. 1991)

– In clays, E_D is derived from an undrained expansion, while M is a drained modulus. (For more details on this specific point see Marchetti 1997).

11.3.2 Young's modulus E'

The Young's modulus E' of the soil skeleton can be derived from M_{DMT} using the theory of elasticity

equation:

$$E' = \frac{(1+\nu)(1-2\nu)}{(1-\nu)} M \quad (13)$$

(e.g. for a Poisson's ratio $\nu = 0.25-0.30$ one obtains $E' \approx 0.8 M_{DMT}$).

The Young's modulus E' should not be derived from (or confused with) the dilatometer modulus E_D .

11.3.3 Maximum shear modulus G_0

No correlation for the maximum shear modulus G_0 was provided by the original Marchetti (1980) paper.

Subsequently, many researchers have proposed correlations relating DMT results to G_0 .

A well documented method was proposed by Hryciw (1990). Other methods are summarized by Lunne et al. (1989) and in US DOT (1992).

Recently Tanaka & Tanaka (1998) found in four NC clay sites (where $K_D \approx 2$) $G_0/E_D \approx 7.5$. They also investigated three sand sites, where they observed that G_0/E_D decreases as K_D increases. In particular they found G_0/E_D decreasing from ≈ 7.5 at small K_D (1.5-2) to ≈ 2 for $K_D > 5$.

Similar trends in sands had been observed e.g. by Sully & Campanella (1989) and Baldi et al. (1989).

11.4 FLOW CHARACTERISTICS AND PORE PRESSURES

11.4.1 Coefficient of consolidation c_h

The method recommended by the authors for deriving c_h from DMT dissipations is the DMT-A method (Marchetti & Totani 1989, ASTM 2001). Another accepted method (ASTM 2001) is the DMT-A₂ method.

The test procedures - and some information on their origin - are described in Section 8.

In all cases the dissipation test consists in stopping the blade at a given depth, then monitoring the decay of the contact pressure σ_h with time. The horizontal coefficient of consolidation c_h is then inferred from the rate of decay.

Note that, as shown by piezocone research, the dissipation rate is governed in most cases predominantly by c_h rather than by c_v , which is the reason why c_h is the target of these procedures.

c_h from DMT-A dissipation

Interpretation of the DMT-A dissipations for evaluating c_h (Marchetti & Totani 1989):

- Plot the $A-\log t$ curve
- Identify the contraflexure point in the curve and the associated time (t_{flex})
- Obtain c_h as

$$c_{h, OC} \approx 7 \text{ cm}^2 / t_{flex} \quad (14)$$

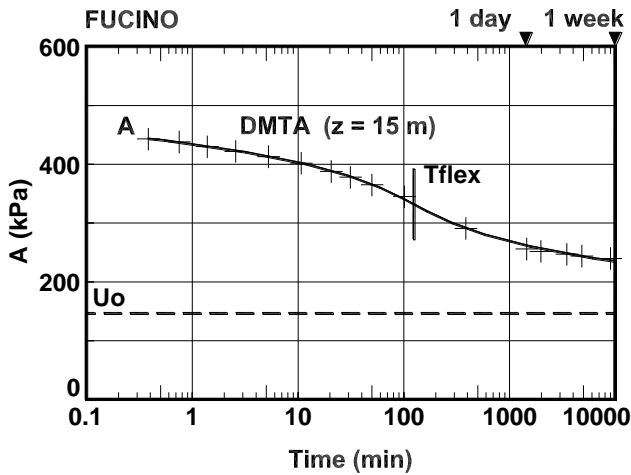

Fig. 27. Example of DMT-A decay curve

It should be noted that c_h from Eq. 14 refers to the soil behavior in the OC range. A c_h value several times lower should be adopted for estimating the settlement rate in a problem involving loading mainly in the NC range.

Comments on the origin of Eq. 14 are given in one of the Notes below.

An example of DMT-A decay curve (Fucino clay) is shown in Fig. 27.

c_h from DMT-A₂ dissipation

Basically the DMT-A₂ method (that can be considered an evolution of the DMT-C method) infers c_h from t_{50} determined from the A_2 -decay dissipation curve. c_h is calculated from t_{50} by using an equivalent radius for the DMT blade and a time factor T_{50} obtained from the theoretical solutions for CPTU.

A detailed description of the method for interpreting the DMT-C dissipation can be found in Robertson et al. (1988), Schmertmann (1988) and US DOT (1992). The DMT-A₂ dissipation can be interpreted in the same way as the DMT-C, with the only difference that the readings A_2 are used in place of the readings C .

A detailed description of the method for interpreting DMT-A₂ dissipation can be found in ASTM 2001.

NOTES

- The DMT-A method does not require the knowledge of the equilibrium pore pressure u_0 , since it uses as a marker point the contraflexure and not the 50 % consolidation point.
- The use of t_{flex} in the DMT-A method is in line with the recent suggestions by Mesri et al. (1999), advocating the preferability of the "inflection point method" for deriving c_v from the oedometer over the usual Casagrande or Taylor methods.

- The DMT-A dissipation test is very similar to the well-established "holding test" by pressuremeter. For such test the theory is available. It was developed by Carter et al. (1979), who established theoretically the S-shaped decay curve of the total contact pressure σ_h vs time (hence the theoretical time factor T_{flex} for the contraflexure point). A similar theory is not available yet for the decay σ_h vs time in the DMT blade, whose shape is more difficult to model. However, since the phenomenon is the same, the theory must have a similar format. The link 7 cm^2 between c_h and t_{flex} in Eq. 14 was determined by experimental calibration. (Determining 7 cm^2 by calibration is similar to determining $T_{50} = 0.197$, in the Terzaghi theory of 1-D consolidation, by field calibration rather than by mathematics). As to *fixity*, in the case of the DMT blade the *fixity* during the holding test is inherently insured, being the blade a solid object.
- Case histories presented by Totani et al. (1998) indicated that the c_h from DMT-A are in good agreement (or "slower" by a factor 1 to 3) with c_h backfigured from field observed behavior.
- The DMT-A₂ method (and the DMT-C method) rely on the assumption that the contact pressure A_2 (or C), after the correction, is approximately equal to the pore pressure u in the soil facing the membrane. Such assumption is generally valid for soft clays, but dubious in more consistent clays. (The DMT-A method, differently, does not rely on such assumption).
- The problem of filter smearing or clogging does not exist with the DMT membrane, because the membrane is anyway a non draining boundary, and what is monitored is a *total* contact stress.

11.4.2 Coefficient of permeability k_h

Schmertmann (1988) proposes the following procedure for deriving k_h from c_h :

- Estimate M_h using $M_h = K_0 M_{DMT}$, i.e. assuming M proportional to the effective stress in the desired direction
- Obtain $k_h = c_h \gamma_w / M_h$ (15)

11.4.3 In situ equilibrium pore pressure by C-readings in sands

The DMT, though non provided with a pore pressure sensor, permits, in free-draining granular soils ($B \geq 2.5 A$), the determination of the pre-insertion ambient equilibrium pore pressure u_0 . Since analysis of the DMT data depends on the in situ effective stress, water pressure is an important and useful information.

The reason why the DMT closing pressure (C -reading) closely approximates u_0 in sand (e.g. Campanella et al. 1985) is the following. During inflation, the membrane displaces the sand away from the blade. During deflation the sand has little tendency to rebound, rather tends to remain away from the membrane, without applying effective pressure to it ($\sigma'_h = 0$, hence $\sigma_h = u_0$). Therefore, at closure, the only pressure on the membrane will be u_0 (see sandy layers in Fig. 28).

This mechanism is well known to pressuremeter investigators, who discovered long ago that the contact pressure, in a disturbed pressuremeter test in sand, is essentially u_0 .

In clay the method does not work because, during deflation, the clay tends to rebound and apply to the membrane some effective stresses. Moreover, in general, $u > u_0$ due to blade penetration. Hence $C > u_0$.

u_0 in sand is estimated as p_2 :

$$u_0 \approx p_2 = C - Z_M + \Delta A \quad (16)$$

(the gage zero offset Z_M is generally taken = 0, more details in Section 9.2).

Before interpreting the C -reading the engineer should insure that the operator has followed the right procedure (Section 5.2), in particular has not incurred in the frequent mistake highlighted in Section 5.2. Note that, in sands, the values expected for C are low numbers, usually < 100 or 200 kPa, i.e. 10 or 20 m of water.

C -readings typically show some experimental scatter. It is therefore preferable to rely on a p_2 profile vs depth, rather than on individual measurements, to provide a pore water pressure trend.

If the interest is limited to finding the u_0 profile, then C -readings are taken in the sandy layers ($B \geq 2.5 A$), say every 1 or 2 m. When the interest, besides u_0 , is to discern free-draining layers from non free-draining layers, then it is recommended to take C -readings routinely at each test depth (see next Section).

More details about the C -reading can be found in Marchetti (1997) and Schmertmann (1988).

11.4.4 Discerning free-draining from non free-draining layers - Index U_D

In problems involving excavations, dewatering, piping/blowup control, flow nets etc. the identification of free-draining/non free-draining layers is important. For such identification, methods based on the DMT C -reading (corrected into p_2 by Eq. 16) have been developed (see Lutenege &

Kabir's 1988 Eq. 2, or Schmertmann's 1988 Eq. 3.7). The basis of the methods making use of the C -reading (or p_2) is the following. As discussed in the previous Section, in free-draining layers $p_2 \approx u_0$. In layers not free-draining enough to reach $\Delta u \approx 0$ in the first minute elapsed since insertion, some excess pore pressure will still exist at the time of the C -reading, hence $p_2 > u_0$.

Therefore: $p_2 = u_0$ indicates a *free-draining* soil, while $p_2 > u_0$ indicates a *non free-draining* soil (Fig. 28).

Index U_D

Based on the above, the pore pressure index U_D was defined by Lutenege & Kabir (1988) as:

$$U_D = (p_2 - u_0) / (p_0 - u_0) \quad (17)$$

In free-draining soils, where $p_2 \approx u_0$, $U_D \approx 0$. In non free-draining soils, p_2 will be higher than u_0 and U_D too.

The example in Fig. 29 (Benoit 1989) illustrates how U_D can discern "permeable" layers ($U_D = 0$), "impermeable" layers ($U_D = 0.7$) and "intermediate permeability" layers (U_D between 0 and 0.7), in agreement with B_q from CPTU.

Note that U_D , while useful for the above scope, cannot be expected to offer a scale over the full range of permeabilities. In fact beyond a certain k the test will be drained anyway, below a certain k the test will be undrained anyway (see Note on next page).

In layers recognized by U_D as non free-draining, quantitative evaluations of c_h can be obtained e.g. using the DMT dissipations described earlier.

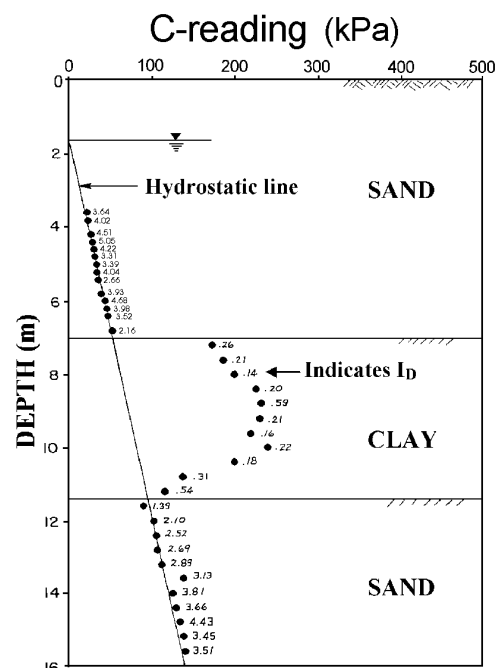

Fig. 28. Use of C -readings for distinguishing free-draining from non free-draining layers (Schmertmann 1988)

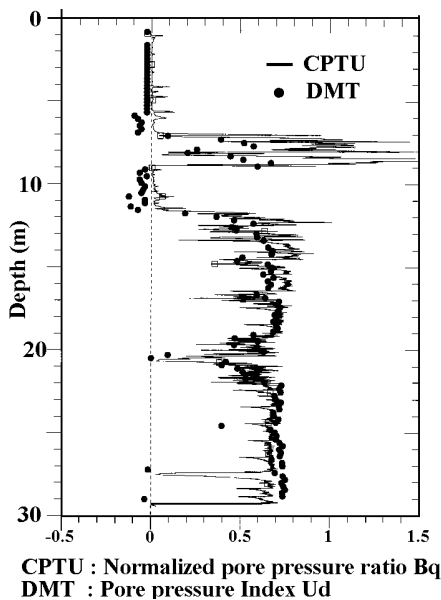

Fig. 29. Use of U_D for discerning free-draining layers ($U_D = 0$) from non free-draining layers (Benoit 1989)

In layers recognized by U_D as free-draining, the DMT dissipations will not be performed (the DMT dissipations are not feasible if most of the dissipation occurs in the first minute, because readings cannot be taken in the first ≈ 15 sec).

NOTE: Drainage conditions during the test

In a clean sand the DMT is a perfectly drained test. Δu is virtually zero throughout the test, whose duration (say 1 minute) is sufficient for any excess to dissipate. In a low permeability clay the opposite is true, i.e. the test is undrained and the excesses do not undergo any appreciable dissipation during the normal test.

It should be noted that, for opposite reasons, the u values in the soil surrounding the blade are constant with time during the test in both cases. In permeable soils everywhere $u = u_0$. In impermeable soils the pore pressures do not dissipate.

There is however a *niche* of soils (in the silts region) for which 1 minute is insufficient for full drainage, but sufficient to permit some dissipation. In these *partial drainage* soils the data obtained can be misleading to an unaware user. In fact the reading B , which follows A by say 15 seconds, is not the "proper match" of A , because in the ≈ 15 seconds from A to B some excess has been dissipating and B is "too low", with the consequence that the difference $B-A$ can also be very low and so the derived values I_D , E_D , M . In such soils I_D will possibly end up in the extreme left hand of its scale ($I_D = 0.1$ or less) and M will also possibly be far too low. Fortunately the sites where this behavior - recognizable by frequent values of $I_D = 0.1$ or less - has been encountered (e.g.

Drammen, Norway) are less than 1 % of the investigated sites.

To be sure, in case of very low I_D and M there is some ambiguity, because the low values of $B-A$ could just be the normal response of a low permeability very soft clay. The ambiguity can be solved with the help of C -readings (or U_D). If the U_D values in the "low $B-A$ " layers are intermediate between those found in the free-draining layers and those found in the non free-draining layers, than the above interpretation of *partial drainage* is presumably correct.

Of course the *partial drainage* explanation can also be verified by means of laboratory sieve analysis or permeability tests. In practice, if the *partial drainage* explanation of the low $B-A$ is confirmed, all results dependent from $B-A$ (recognizable by very depressed I_D troughs) have to be ignored.

12. PRESENTATION OF DMT RESULTS

Fig. 30 shows the recommended graphical format of the DMT output. Such output displays four profiles: I_D , M , c_u and K_D . Experience has shown that these four parameters are generally the most significant group to plot (for reliability, expressivity, usefulness). Note that K_D , though not a common soil parameter, has been selected as one to be displayed as generally helpful in "understanding" the site history, being similar in shape to the OCR profile. It is also recommended that the diagrams be presented side by side, and not separated. It is beneficial for the user to see the diagrams together.

The graphical output contains only the main profiles. The numerical values of these and other parameters are listed in the tabular output normally accompanying the graphical output (see example in Fig. 31).

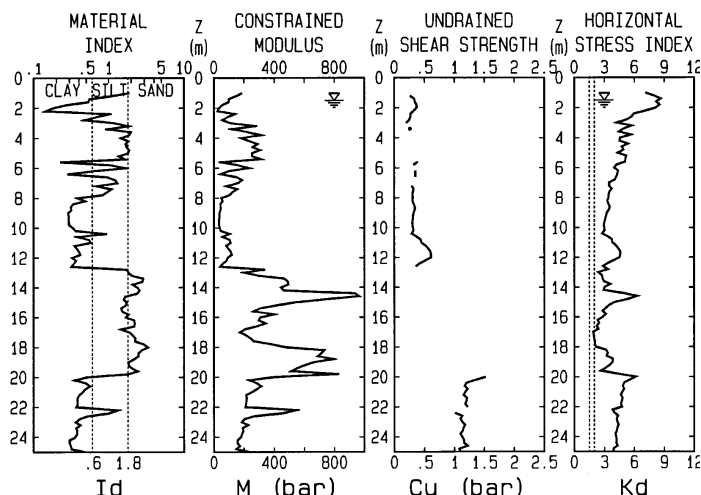

Fig. 30. Recommended graphical presentation of DMT results - (1 bar = 100 kPa)

Reduction formulae according to ASCE Geot.Jnl.,Mar. 1980, Vol.109, 299-321

NOTE : OCR = 'relative OCR'. OCR below often reasonable. Accuracy can be improved if precise OCR values are available. Then factorize all OCR below by the ratio $OCR_{reference}/OCR$

Po	= Corrected A reading	bar	INTERPRETED GEOTECHNICAL PARAMETERS	
P1	= Corrected B reading	bar	-----	
Gamma	= Bulk unit weight/GammaH2O	(-)	Ko = In situ earth press. coeff.	(-)
Sigma'	= Effective overb. stress	bar	Ocr= Overconsolidation ratio	(-)
U	= Pore pressure	bar	Phi= Safe floor value of friction angle	(-)
Id	= Material Index	(-)	M = Constrained modulus (at Sigma')	bar
Kd	= Horizontal stress index	(-)	Cu = Undrained shear strength	bar
Ed	= Dilatometer modulus	bar		

Z (m)	Po	P1	Gamma	Sigma'	U	Id	Kd	Ed	Ko	Ocr	Phi	M	Cu	DESCRIPTION
1.00	1.2	3.5	1.80	0.17	0.00	1.89	7.1	85			39	186		SILTY SAND
1.20	1.6	3.4	1.70	0.21	0.00	1.09	7.9	66	1.6	8.6		150	0.26	SILT
1.40	2.1	3.2	1.70	0.24	0.00	0.56	8.6	43	1.7	9.8		100	0.33	SILTY CLAY
1.60	2.2	3.3	1.70	0.26	0.01	0.53	8.2	43	1.6	9.0		98	0.34	SILTY CLAY
1.80	2.4	3.0	1.60	0.28	0.03	0.27	8.5	23	1.7	9.6		55	0.37	CLAY
2.00	2.4	2.8	1.60	0.29	0.05	0.18	8.2	16	1.6	9.0		36	0.37	CLAY
2.20	2.2	2.5	1.50	0.30	0.07	0.15	7.1	12	1.5	7.3		25	0.32	MUD
2.40	1.9	3.8	1.70	0.31	0.09	1.02	6.0	70	1.3	5.5		139	0.27	SILT
2.60	2.0	3.2	1.70	0.32	0.11	0.68	5.7	47	1.3	5.2		90	0.27	CLAYEY SILT
2.80	1.9	2.7	1.60	0.34	0.13	0.48	5.2	31	1.2	4.4		57	0.25	SILTY CLAY
3.00	1.6	3.4	1.70	0.35	0.15	1.19	4.3	66	1.0	3.3		110	0.20	SILT
3.20	2.2	6.0	1.80	0.36	0.17	1.81	5.7	140			38	276		SILTY SAND
3.40	2.0	3.8	1.70	0.38	0.19	0.96	4.9	66	1.1	4.0		118	0.26	SILT
3.60	2.0	5.4	1.80	0.39	0.21	1.97	4.5	128			37	224		SILTY SAND
3.80	2.5	6.8	1.90	0.41	0.23	1.87	5.6	159			38	312		SILTY SAND
4.00	2.2	5.0	1.70	0.43	0.25	1.45	4.6	105			37	183		SANDY SILT
4.20	2.3	5.9	1.80	0.44	0.26	1.85	4.5	136			37	238		SILTY SAND
4.40	2.7	6.8	1.80	0.46	0.28	1.67	5.4	152			38	289		SANDY SILT
4.60	2.5	6.4	1.70	0.47	0.30	1.73	4.7	144			37	258		SANDY SILT
4.80	2.7	7.2	1.90	0.49	0.32	1.89	4.9	167			37	306		SILTY SAND
5.00	2.5	6.5	1.80	0.50	0.34	1.82	4.4	148			36	253		SILTY SAND
5.20	3.1	6.7	1.80	0.52	0.36	1.37	5.2	136			37	253		SANDY SILT
5.40	3.1	7.6	1.80	0.53	0.38	1.65	5.1	167			37	310		SANDY SILT
5.60	3.2	3.8	1.70	0.55	0.40	0.23	5.1	23	1.2	4.3		42	0.39	CLAY
5.80	2.8	5.4	1.70	0.56	0.42	1.10	4.2	97	1.0	3.2		160	0.32	SILT
6.00	2.7	6.6	1.80	0.58	0.44	1.69	4.0	144			36	233		SANDY SILT
6.20	3.1	4.6	1.70	0.59	0.46	0.61	4.4	58	1.1	3.4		96	0.35	CLAYEY SILT
6.40	3.1	3.8	1.70	0.61	0.48	0.28	4.3	27	1.0	3.3		44	0.35	CLAY
6.60	3.1	5.6	1.70	0.62	0.50	0.97	4.2	93	1.0	3.2		152	0.35	SILT
6.80	3.1	6.2	1.70	0.63	0.52	1.23	4.0	117			36	187		SANDY SILT
7.00	2.8	5.7	1.70	0.65	0.54	1.31	3.5	109			35	159		SANDY SILT
7.20	2.9	4.4	1.70	0.66	0.56	0.69	3.5	58	0.88	2.4		83	0.29	CLAYEY SILT
7.40	3.1	5.8	1.70	0.68	0.58	1.08	3.7	101	0.93	2.6		154	0.32	SILT
7.60	3.0	5.3	1.70	0.69	0.60	0.95	3.5	85	0.89	2.4		124	0.31	SILT
7.80	3.0	5.0	1.70	0.70	0.62	0.83	3.4	74	0.88	2.3		105	0.30	SILT
8.00	3.1	4.0	1.70	0.72	0.64	0.39	3.4	35	0.87	2.3		49	0.31	SILTY CLAY
8.20	3.1	4.2	1.70	0.73	0.66	0.48	3.3	43	0.85	2.2		58	0.30	SILTY CLAY
8.40	3.2	4.0	1.70	0.74	0.68	0.33	3.4	31	0.86	2.3		43	0.32	SILTY CLAY
8.60	3.4	4.2	1.70	0.76	0.70	0.31	3.6	31	0.90	2.4		45	0.34	CLAY
8.80	3.4	4.2	1.70	0.77	0.72	0.31	3.5	31	0.88	2.4		44	0.34	CLAY
9.00	3.3	4.0	1.70	0.79	0.74	0.29	3.3	27	0.84	2.1		37	0.32	CLAY
9.20	3.3	4.0	1.70	0.80	0.76	0.29	3.2	27	0.82	2.1		36	0.31	CLAY
9.40	3.3	4.0	1.70	0.81	0.77	0.29	3.1	27	0.81	2.0		35	0.31	CLAY
9.60	3.3	4.0	1.70	0.83	0.79	0.29	3.0	27	0.79	1.9		35	0.30	CLAY
9.80	3.3	4.0	1.70	0.84	0.81	0.30	3.0	27	0.77	1.8		34	0.30	CLAY
10.00	3.4	4.2	1.70	0.85	0.83	0.33	3.0	31	0.78	1.9		39	0.31	CLAY
10.20	3.5	4.4	1.70	0.87	0.85	0.36	3.0	35	0.79	1.9		45	0.32	SILTY CLAY
10.40	3.3	5.6	1.70	0.88	0.87	0.94	2.8	85	0.74	1.7		104	0.29	SILT
10.60	3.9	5.0	1.70	0.90	0.89	0.39	3.3	43	0.85	2.2		59	0.37	SILTY CLAY

Fig. 31. Example of numerical output of DMT results - (1 bar = 100 kPa)

All input data, in particular the uncorrected field readings *A* and *B* and the calibration values ΔA and ΔB , must always be reported, either in a separate document or as added columns in the above tabular output.

Figs. 32 and 33 show examples of DMT results in predominantly NC and OC sites. The condition NC or OC is clearly identified by K_D (K_D in the vertical band between the two dashed lines ($K_D = 1.5-2$) in NC sites, higher K_D in OC sites).

13. APPLICATION TO ENGINEERING PROBLEMS

As mentioned earlier, the primary way of using DMT results is "design via parameters".

This Section provides some details on the use of DMT in some specific applications.

13.1 SETTLEMENTS OF SHALLOW FOUNDATIONS

Predicting settlements of shallow foundations is probably the No. 1 application of the DMT, especially in sands, where undisturbed sampling and estimating compressibility are particularly difficult.

Settlements are generally calculated by means of the one-dimensional formula (Fig. 34):

$$S_{1-DMT} = \sum \frac{\Delta\sigma_v}{M_{DMT}} \Delta z \quad (18)$$

with $\Delta\sigma_v$ generally calculated according to Boussinesq and M_{DMT} constrained modulus estimated by DMT.

It should be noted that the above formula, being based on linear elasticity, provides a settlement *proportional* to the load, and is unable to provide a non linear prediction. The predicted settlement is meant to be the *settlement in "working conditions"* (i.e. for a safety factor $F_s = 2.5$ to 3.5).

13.1.1 Settlements in sand

Settlements analyses in sand are generally carried out using the 1-D elasticity formula (in 1-D problems, say *large* rafts or embankments) or the 3-D elasticity formula (in 3-D problems, say *small* isolated footings). However, based on considerations by many Authors (e.g. Burland et al. 1977), it is recommended to use the 1-D formula (Eq. 18) in *all* cases. The reasons are illustrated in detail by Marchetti (1997). In case it is opted for the use of the 3-D formulae, E' can be derived from M using the theory of elasticity, that, for $\nu = 0.25$, provides $E' = 0.83 M$ (a factor not very far from unity). Indeed M and E' are often used interchangeably in view of the involved approximation.

13.1.2 Settlements in clay

Eq. 18 is also recommended for predicting settlements in clay. The calculated settlement is the *primary* settlement (i.e. net of immediate and secondary), because M_{DMT} is to be treated as the average E_{oed} derived from the oedometer curve

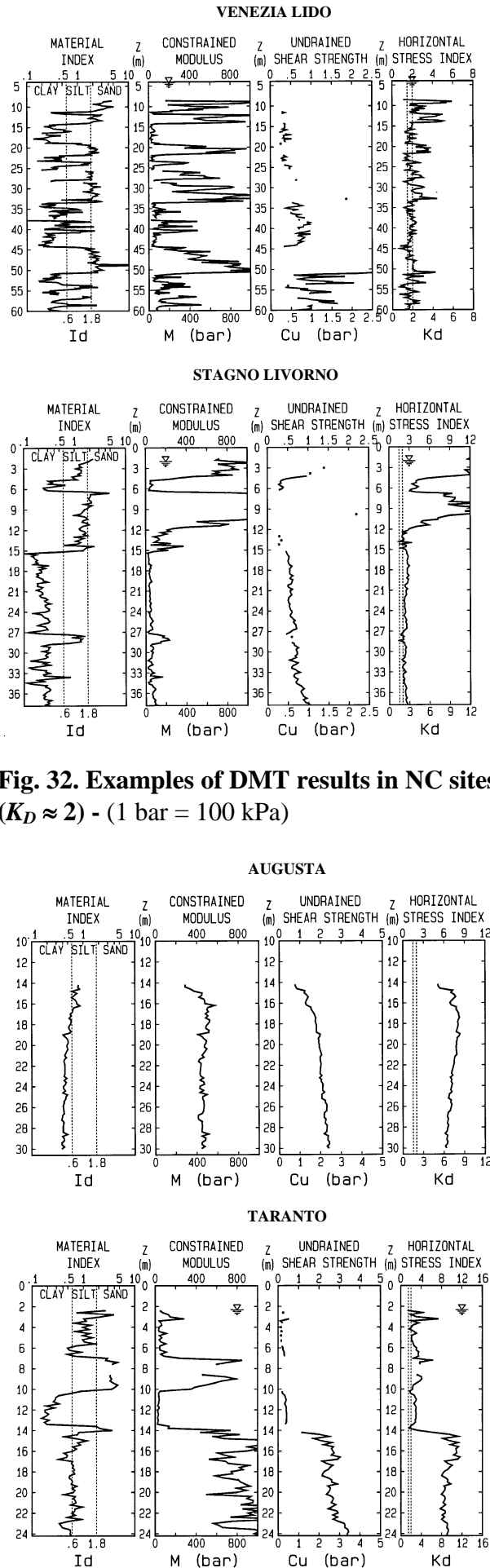

Fig. 32. Examples of DMT results in NC sites ($K_D \approx 2$) - (1 bar = 100 kPa)

Fig. 33. Examples of DMT results in OC sites ($K_D \gg 2$) - (1 bar = 100 kPa)

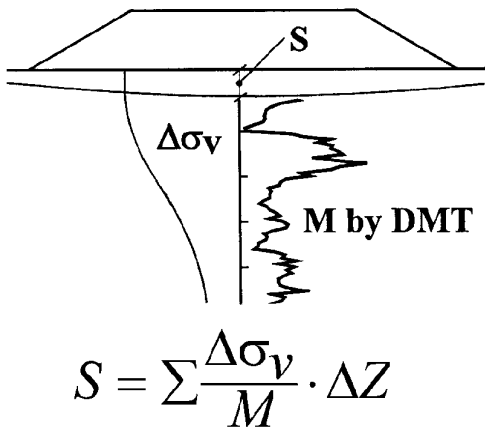

Fig. 34. Recommended settlement calculation

in the expected stress range.

It should be noted that in some highly structured clays, whose oedometer curves exhibit a sharp break and a dramatic reduction in slope across the preconsolidation pressure p'_c , M_{DMT} could be an inadequate average if the loading straddles p'_c . However in many common clays, and probably in most natural sands, the M fluctuation across p'_c is mild, and M_{DMT} can be considered an adequate average modulus.

In 3-D problems in OC clays, "according to the book", the Skempton-Bjerrum correction should be applied. Such correction in OC clays is often in the range 0.2 to 0.5 ($\ll 1$). However considering that:

- The application of the Skempton-Bjerrum correction is equivalent to reducing S_{I-DMT} by a factor 2 to 5
- Terzaghi & Peck's book states that in OC clays "the modulus from even good oedometers may be 2 to 5 times smaller than the in situ modulus"

these two factors approximately cancel out.

Therefore it is suggested to adopt as *primary* settlement (even in 3-D problems in OC clays) directly S_{I-DMT} from Eq. 18, *without* the Skempton-Bjerrum correction (while adopting, if applicable, the rigidity and the depth corrections).

13.1.3 Comparison of DMT-calculated vs observed settlements

Many investigators have presented comparisons of observed vs DMT-predicted settlements, reporting generally satisfactory agreement.

Schmertmann (1986) reports 16 case histories at various locations and for various soil types. He found an average ratio calculated/observed settlement ≈ 1.18 , with the value of that ratio mostly in the range 0.75 to 1.3.

Fig. 35 (Hayes 1990) confirms the good agreement

for a wide settlement range. In such figure the band amplitude of the datapoints (ratio between maximum and minimum) is approximately 2. Or the observed settlement is within $\pm 50\%$ from the DMT-predicted settlement.

Similar agreement has been reported by others (Lacasse & Lunne 1986, Skiles & Townsend 1994, Steiner et al. 1992, Steiner 1994, Woodward & McIntosh 1993, Failmezger et al. 1999, Didaskalou 1999, Pelnik et al. 1999).

13.2 AXIALLY LOADED PILES

13.2.1 Driven piles

13.2.1.1 The DMT- σ_{hc} method for piles driven in clay

The DMT- σ_{hc} method (Marchetti et al. 1986) was developed for the case of piles driven in clays. The method is based on the determination of σ'_{hc} (effective horizontal stress against the DMT blade at the end of the reconsolidation). Then a ρ factor is applied to σ'_{hc} , and the product is used as an estimate of the pile skin friction ($f_s = \rho \sigma'_{hc}$).

The DMT- σ_{hc} method has conceptual roots in the theories developed by Baligh (1985). However, in practice, the method has two drawbacks:

- (a) In clays, the determination of σ'_{hc} can take considerable time (the reconsolidation around the blade in low permeability clays can take many hours, if not one or two days), which makes the σ'_{hc} determination expensive (especially in offshore investigations).
- (b) The ρ factor has been found to be not a constant, but a rather variable factor (mostly in the range 0.10 to 0.20). Therefore, until methods for

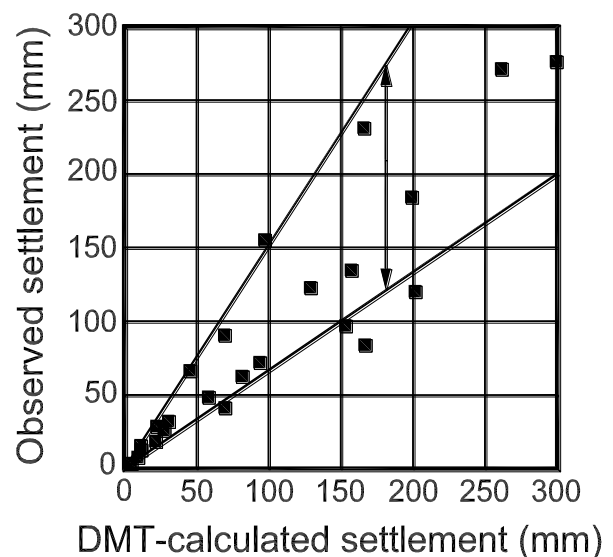

Fig. 35. Observed vs DMT-calculated settlements (Hayes 1990)

more reliable estimates of ρ are developed, the uncertainty in f_s is too wide. Nevertheless, in important jobs, the method could helpfully be used to supplement other methods, e.g. for getting information on the shape of the f_s profile, or for estimating a lower bound value of f_s using $\rho = 0.10$.

13.2.1.2 Method by Powell et al. (2001 b) for piles driven in clay

Powell et al. (2001 b) developed a new method for the design of axially loaded piles driven in clay by DMT. The method was developed based on load tests on about 60 driven or jacked piles at 10 clay sites in UK, Norway, France and Denmark, as part of an EC Brite EuRam Project.

This method predicts the pile skin friction q_s from the material index I_D and $(p_1 - p_0)$. The recommended design formulae for skin friction in clay (both tension and compression piles) are:

$$I_D < 0.1 \quad q_s / (p_1 - p_0) = 0.5 \quad (19)$$

$$0.1 < I_D < 0.65 \quad q_s / (p_1 - p_0) = -0.73077 I_D + 0.575 \quad (20)$$

$$I_D > 0.65 \quad q_s / (p_1 - p_0) = 0.1 \quad (21)$$

A slightly *modified* form of the above equations was proposed for predicting q_s of *compression piles only*:

$$I_D < 0.6 \quad q_s / (p_1 - p_0) = -1.1111 I_D + 0.775 \quad (22)$$

$$I_D > 0.6 \quad q_s / (p_1 - p_0) = 0.11 \quad (23)$$

For the upper parts of the pile where $h/R > 50$ (h = distance along the pile upwards from the tip, and R = pile radius), in both cases the above values should be multiplied by 0.85.

The pile unit end resistance q_p is evaluated as:

$$q_p = k_{di} p_{1e} \quad (24)$$

where p_{1e} is the *equivalent* p_1 (a suitable average beneath the base of the pile) and k_{di} is the "DMT bearing capacity factor". For closed ended driven piles the recommended values for k_{di} are:

$$\text{for } E_D > 2 \text{ MPa} \quad k_{di} = 1.3 \quad (25)$$

$$\text{for } E_D < 2 \text{ MPa} \quad k_{di} = 0.7 \quad (26)$$

For open ended piles multiply these values by 0.5.

The criteria for the variation of k_{di} with soil type need to be established from a larger database to establish the transition at $E_D = 2$ MPa.

Based on comparisons with the measured capacity of a large number of piles, Powell et al. (2001 a & b) conclude that the *general* shaft resistance method for all piles (*both tension and compression*) shows good potential for use in design, and performs at least as well as other methods currently available.

The *modified* method for estimating q_s for *compression piles only* based on DMT (Eqns. 22 -

23) was found to predict more accurately the

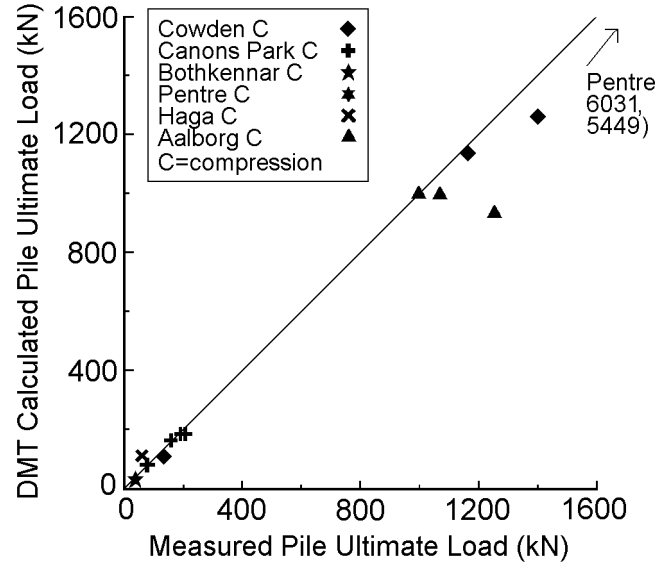

Fig. 36. Predicted vs measured ultimate pile capacity using the DMT compression pile method (Powell et al. 2001 a)

observed shaft capacity of compression piles, q_p being derived as above (Fig. 36). This modified method based on DMT was found to outperform other methods investigated for compression piles (Powell et al. 2001 a).

13.2.1.3 Horizontal pressure against piles driven in clay during installation

Totani et al. (1994) report a finding of practical interest to engineers having to decide the thickness of the shell of mandrel-driven piles in clay. The paper describes measurements of σ_h (total) on a pile 57 m long, 508/457 mm in diameter, driven in a slightly OC clay. The pile was instrumented with 8 total pressure cells. Cells readings (σ_h against the pile) were taken during pauses in driving. The σ_h values were found at each depth virtually equal to p_0 determined by a normal DMT.

This finding is in accordance to theoretical findings by Baligh (1985), predicting σ_h independent from the dimensions of the penetrating object (these results suggest independence of σ_h even from the shape).

13.2.1.4 Low skin friction in calcareous sand

Some calcareous sands are known to develop unusually low skin friction, hence very low lateral pile capacity.

DMTs performed in calcareous sands (Fig. 37) have indicated unusually low K_D values. This suggests: (a) The low f_s in these sands is largely due to low σ'_h . (b) The low K_D in calcareous sands is a possible useful warning of low skin friction.

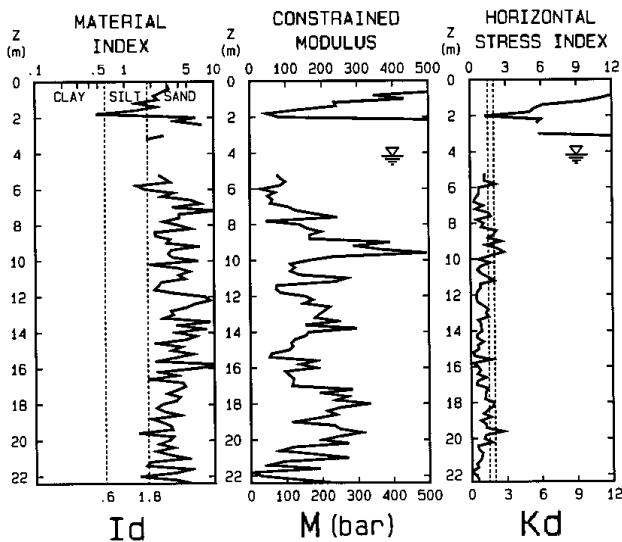

Fig. 37. DMT results in the Plouasne (Brittany) calcareous sand ($K_D \ll 2$) - (1 bar = 100 kPa)

13.2.2 Screw piles

Peiffer (1997) developed a method for estimating the skin friction of Atlas screw piles based on p_0 from DMT.

The DMT is run in the usual way, but is performed next to the pile (one diameter away from the shaft) *after* its execution.

This method is intermediate between a real design method and a pile load test. It is not a pre-execution design method, because the skin friction is estimated after the pile has been executed. Nor is it a load test, because the skin friction is estimated not by loading the pile, but from DMT-determined properties of the after-pile-installation soil, in accord with the widely recognized notion that pile capacity largely depends on execution, besides soil type.

13.2.3 Bored piles

No special DMT-based methods have been developed for the design of bored piles, which is generally carried out via soil parameters.

However the method developed by Peiffer (1997) for skin friction on screw piles (perform DMT in the soil surrounding the pile, see above Section) is in principle applicable also to bored piles.

13.2.4 Monitoring pile installation effects

The DMT has also been used extensively by Ghent investigators (Peiffer & Van Impe 1993, Peiffer et al. 1993, Peiffer et al. 1994, De Cock et al. 1993) for *comparing soil changes caused by various pile installation methods*. For instance De Cock et al. (1993) describe the use of before/after DMTs to verify, in terms of K_D , the installation effects of the Atlas pile (Fig. 38).

13.3 LATERALLY LOADED PILES

Methods have been developed for deriving P - y curves from DMT results. For the single pile the authors recommend the methods developed by Robertson et al. (1987) and by Marchetti et al. (1991). Note that all methods address the case of first time monotonic loading.

13.3.1 Robertson et al. (1987) method (clays and sands)

The Robertson method is an adaptation of the early methods (Skempton ε_{50} - Matlock 1970 cubic parabola approach) estimating the P - y curves from soil properties obtained in the laboratory. In the Robertson method such "laboratory soil properties" are inferred from DMT results. Then the method continues in the same way as the Matlock method.

A detailed description of the step-by-step procedure to derive the P - y curves from DMT, both for sands and clays, can be found in Robertson et al. (1987), or in US DOT (1992).

Validations of the Robertson method by Marchetti et al. (1991) indicated, for various cases, remarkably good agreement between predicted and observed behavior.

13.3.2 Marchetti et al. (1991) method (clays)

Marchetti et al. (1991) developed further the Robertson method for clay, eliminating from the correlation chain the tortuous step of estimating by DMT the "laboratory soil properties", and evolved a procedure for deriving the P - y curves directly from DMT data (in clays).

The P - y curve at each depth is completely defined by a hyperbolic tangent equation having the

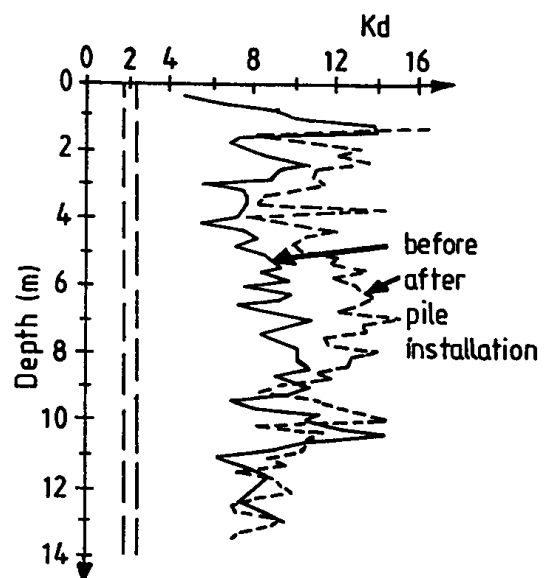

Fig. 38. Before/after DMTs for comparing installation effects of various piles (here an Atlas pile) - DeCock et al. (1993)

non-dimensional form:

$$\frac{P}{P_u} = \tanh\left(\frac{E_{si} \cdot y}{P_u}\right) \quad (27)$$

with

$$P_u = \alpha \cdot K_1 \cdot (p_0 - u_0) \cdot D \quad (28)$$

$$E_{si} = \alpha \cdot K_2 \cdot E_D \quad (29)$$

$$\alpha = \frac{1}{3} + \frac{2}{3} \cdot \frac{z}{7 \cdot D} \leq 1 \quad (30)$$

where

P_u = ultimate lateral soil resistance [F/L]

E_{si} = initial tangent "soil modulus" [F/L²]

α = non-dimensional reduction factor for depths less than $z = 7D$ (α becomes 1 for $z = 7D$)

p_0 = corrected first DMT reading

u_0 = in situ pore pressure

D = pile diameter

z = depth

K_1 = empirical soil resistance coefficient: $K_1 = 1.24$

K_2 = empirical soil stiffness coefficient:

$$K_2 = 10 \cdot (D/0.5 \text{ m})^{0.5}$$

The authors had several occasions to compare the behavior of laterally loaded test piles with the behavior predicted by the Marchetti et al. (1991) method. They found an amazingly good agreement between observed and predicted pile deflections.

A number of independent validations (NGI, Georgia Tech and tests in Virginia sediments) have indicated that the two methods provide similar predictions, in good agreement with the observed behavior.

It has been noted that DMT provides data even at shallow depths, i.e. in the layers dominating pile response.

13.3.3 Laterally loaded pile groups

A method was developed by Ruesta & Townsend in 1997. The method, based on the results of a large-scale load test on a 16 piles group, derives the P - y curves from DMT/PMT.

13.4 DETECTING SLIP SURFACES IN OC CLAY SLOPES

Totani et al. (1997) developed a quick method for detecting active or old slip surfaces in OC clay slopes, based on the inspection of the K_D profiles. The method is based on the following two elements:

(a) The sequence of sliding, remolding and reconsolidation (illustrated in Fig. 39) generally creates a remolded zone of nearly normally consolidated clay, with loss of structure, aging or cementation.

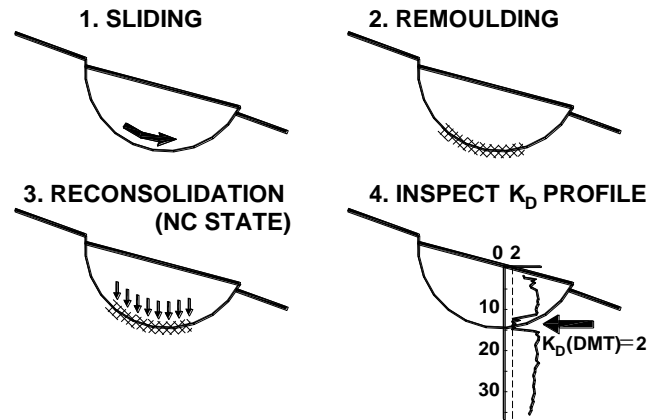

Fig. 39. DMT- K_D method for detecting slip surfaces in OC clay slopes

(b) Since in NC clays $K_D \approx 2$, if an OC clay slope contains layers where $K_D \approx 2$, these layers are likely to be part of a slip surface (active or quiescent).

In essence, the method consists in identifying zones of NC clay in a slope which, otherwise, exhibits an OC profile, using $K_D \approx 2$ as the identifier of the NC zones. Note that the method involves searching for a specific numerical value ($K_D = 2$) rather than for simply "weak zones", which could be detected just as easily also by other in situ tests.

The method was validated by inclinometers or otherwise documented slip surfaces (see Fig. 40).

The " K_D method" provides a faster response than inclinometers in detecting slip surfaces (no need to

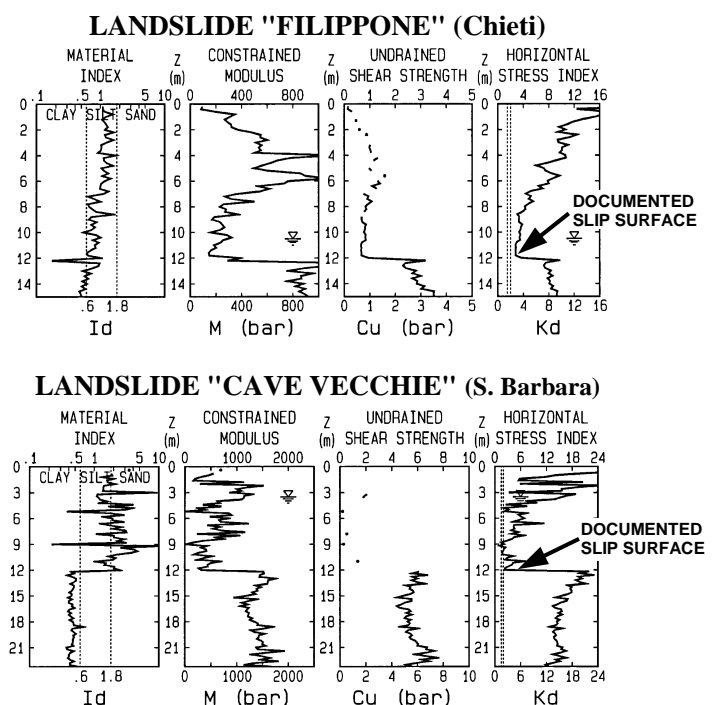

Fig. 40. Examples of $K_D \approx 2$ in documented slip surfaces in two OC clay slopes - (1 bar = 100 kPa)

wait for movements to occur). Moreover, the method enables to detect even possible quiescent surfaces (not revealed by inclinometers), which could reactivate e.g. after an excavation.

On the other hand, the method itself, unlike inclinometers, does not permit to establish if the slope is moving at present and what the movements are. In many cases, DMT and inclinometers can be used in combination (e.g. use K_D profiles to optimize location/depth of inclinometers).

13.5 MONITORING DENSIFICATION / K_0 INCREASE

The DMT has been used in several cases for monitoring soil improvement, by comparing DMT results before and after the treatment (see e.g. Fig. 41). Compaction is generally reflected by a brisk increase of both K_D and M .

Schmertmann et al. (1986) report a large number of before/after CPTs and DMTs carried out for monitoring dynamic compaction at a power plant site (mostly sand). The treatment increased substantially both q_c and M_{DMT} . The increase in M_{DMT} was found to be approximately *twice* the increase in q_c .

Jendebly (1992) reports before/after CPTs and DMTs carried out for monitoring the deep compaction produced in a loose sand fill with the "vibrowing". He found a substantial increase of both q_c and M_{DMT} , but M_{DMT} increased at a faster rate (nearly *twice*, see Fig. 42), a result similar to the previous case.

Pasqualini & Rosi (1993), in monitoring a vibroflotation treatment, noted that the DMT clearly

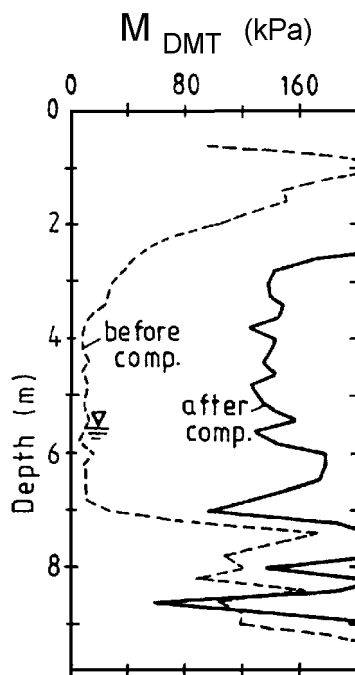

Fig. 41. Before/after DMTs for compaction control (resonant vibrocompaction technique, Van Impe et al. 1994)

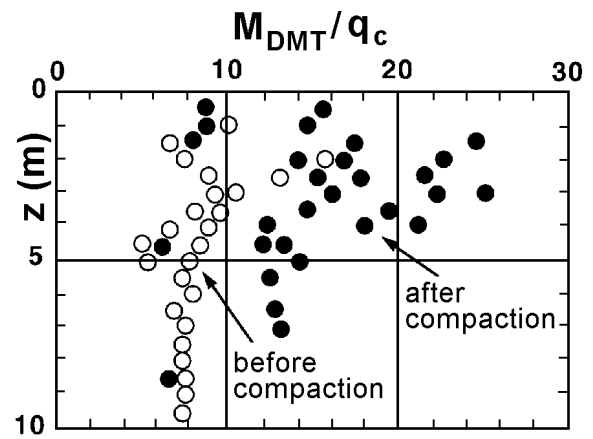

Fig. 42. Ratio M_{DMT}/q_c before/after compaction of a loose sand fill (Jendebly 1992)

detected the improvement even in layers marginally influenced by the treatment, where the benefits were undetected by CPT.

All the above results concurrently suggest that the DMT is sensitive to changes of stresses/density in the soil and therefore is well suited to detect the benefits of the soil improvement (in particular increased σ_h and increased D_r).

An interesting consideration by Schmertmann et al. (1986) is that, since treatments are often aimed at reducing settlements, it would be more rational to base the control and set the specifications in terms of minimum M rather than of minimum D_r .

Stationary DMT as pressure sensing elements

DMT blades have also been used to sense variations in stress state/density using them not as penetration tools, but as stationary spade cells. In this application DMT blades are inserted at the levels where changes are expected, then readings (only A) are taken with time. Various applications of this type have been reported. Peiffer et al. (1994) show (Fig. 43)

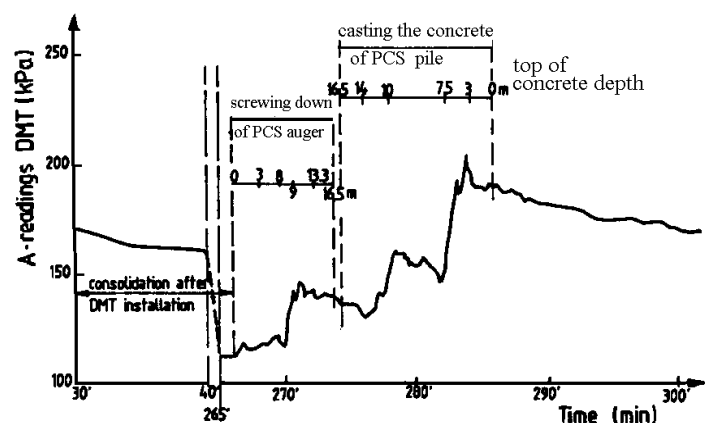

Fig. 43. Stationary DMT blades left in place to feel stress variations caused by the nearby installation of a screw pile (Peiffer et al. 1994)

representative results of such application, where a DMT blade was left in the soil waiting for the installation of a PCS auger pile. The clear distance between the blade and pile face was 1 pile diameter. Sufficient time was allowed for stabilization of the A-reading before the pile insertion.

Fig. 43 shows that the A-readings reflected clearly the reconsolidation, the screwing of the piles and the casting of the concrete.

It should be noted, however, that DMT blades used as stationary pressure cells, while able to detect stress variations, do not provide absolute estimates of the stresses before and after installation, in contrast with before/after continuous DMTs. Moreover each stationary blade can provide information only at one location.

13.6 MONITORING SOIL DECOMPRESSION

The DMT has been used not only to feel the increase, but also the reduction of density or horizontal stress.

Peiffer and his colleagues, as mentioned in Section 13.2.4, used the DMT to monitor the decompression caused by various types of piles.

Some investigators (e.g. Hamza & Richards 1995 for Cairo Metro works) have used before/after DMTs to get information on stress changes in the decompressed volume of soil behind diaphragm walls.

13.7 SUBGRADE COMPACTION CONTROL

Some experience exists on the use of DMT for evaluating the suitability of the compacted ground surface (i.e. the subgrade soil) to support the road superstructure (subbase, base, pavements).

Borden (1986), based on laboratory work on A-2-4 to A-7-5 soils, tentatively suggested to estimate CBR % (corrected, unsoaked) as:

$$\text{CBR \%} = 0.058 E_D (\text{bar})^{-0.475} \quad (31)$$

(1 bar = 100 kPa)

Marchetti (1994) describes the use of DMT as a fast acceptance tool for the subgrade compaction in a road in Bangladesh. The procedure was the following:

- Perform a few preliminary DMTs in the accepted subgrade (i.e. satisfying the contract specifications)
- Draw an average profile through the above M_{DMT} profiles and use it as an acceptance profile (Fig. 44).

The acceptance M_{DMT} profile could then be used as an economical production method for quality control of the compaction, with only occasional verifications by the originally specified methods (Proctor, laboratory/in situ CBR and plate load tests).

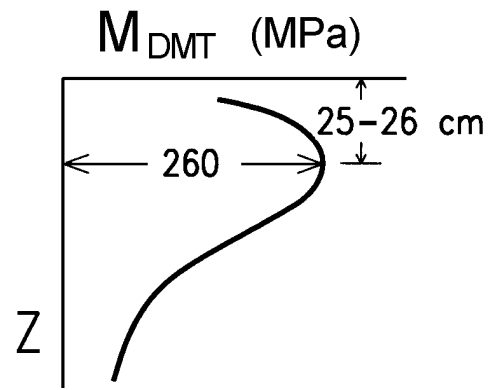

Fig. 44. Example of M_{DMT} acceptance profile for verifying subgrade compaction (Marchetti 1994)

Interestingly, all the after-compaction M_{DMT} profiles had the typical shape of the profile shown in Fig. 44, with the maximum M_{DMT} found almost invariably at 25-26 cm depth.

Cases have been reported of after-construction checks with the blade penetrating directly through asphalt.

It can be noted that many today's methods of pavement design make use of moduli rather than other parameters. Hence the availability of the M_{DMT} profiles may be of some usefulness.

13.8 LIQUEFACTION

Fig. 45 summarizes the available knowledge for evaluating sand liquefiability by DMT. The curve currently recommended to estimate the cyclic resistance ratio (CRR) from the parameter K_D is the curve by Reyna & Chameau (1991). Such curve is based for a significant part on their curve K_D-D_r (relative to NC sands) shown in Fig. 21.

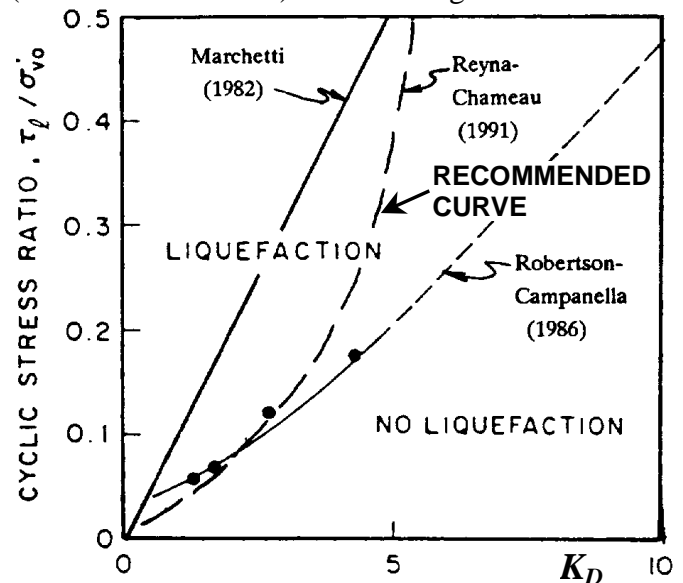

Fig. 45. Recommended curve for estimating CRR from K_D (Reyna & Chameau 1991)

This K_D - D_r correlation has been confirmed by additional datapoints obtained by Tanaka & Tanaka (1998) at the sites of Ohgishima and Kemigawa, where D_r was determined on high quality frozen samples.

Once CRR has been evaluated from Fig. 45, it is used in liquefaction analysis with the methods developed by Seed (a detailed step-by-step procedure can be found in US DOT 1992).

The high sensitivity of K_D in monitoring densification suggests that K_D may be a sensitive parameter also for sensing sand liquefiability.

In fact a liquefiable sand may be regarded as a sort of "negatively compacted" sand, and it appears plausible that the DMT sensitivity holds in the positive and negative range.

Fig. 45, in combination with the available experience (see Marchetti 1997), suggests that a clean sand (natural or sandfill) is adequately safe against liquefaction ($M = 7.5$ earthquakes) for the following K_D values:

- Non seismic areas: $K_D > 1.7$
- Low seismicity areas ($a_{max}/g = 0.15$): $K_D > 4.2$
- Medium seismicity areas ($a_{max}/g = 0.25$): $K_D > 5.0$
- High seismicity areas ($a_{max}/g = 0.35$): $K_D > 5.5$

13.9 USE OF DMT FOR FEM INPUT PARAMETERS

Various approaches have been attempted so far.

- (a) Use the simplest possible model (linear elastic) assigning to the Young's modulus $E' \approx 0.8 M_{DMT}$. An example of such application is illustrated by Hamza & Richards (1995).
- (b) Model the dilatometer test by a finite elements (FEM) computer program by adjusting the input parameters until the DMT results are correctly "predicted". This approach has the shortcoming of requiring many additional (unknown) parameters.
- (c) Another more feasible approach, in problems where linear elasticity is known to give inadequate answers (e.g. settlements outside diaphragm walls), is to check preliminarily the set of intended FEM parameters as follows. Predict for a case of simple loading the settlement by DMT (generally predicting well such settlements - see Section 13.1). Then repeat for the same loading case the settlement prediction by FEM. The comparison of the two predicted settlements may help in the final choice of the FEM parameters.

- (d) Other approaches try to identify an "equivalent representative average" DMT strain, with the intent of producing a point in the G - γ degradation curve.

14. SPECIAL CONSIDERATIONS

14.1 DISTORTIONS CAUSED BY THE PENETRATION

Fig. 46 compares the distortions caused in clay by conical tips and by wedges (Baligh & Scott 1975). The deformed grids show that distortions are considerably lower for wedges.

Davidson & Boghrat (1983) observed, using a stereo photograph technique, the strains produced in sand by CPT tips and by DMT blades. The strains in the sand surrounding the cone were found to be considerably higher.

14.2 PARAMETER DETERMINATION BY "TRIANGULATION"

In situ tests represent an "inverse boundary conditions" problem, since they measure *mixed* soil responses rather than *pure* soil properties. In order to isolate *pure* soil properties, it is necessary a "triangulation" (a sort of matrix inversion).

The "triangulation" is possible if more than one response has been measured.

The availability of two independent responses by DMT permits some elementary form of response combination. E.g. M_{DMT} is obtained using both p_0 and p_1 .

It may be remarked that one of the two responses, p_0 (hence K_D), reflects stress history, a factor often dominating soil behavior (e.g. compressibility, liquefiability).

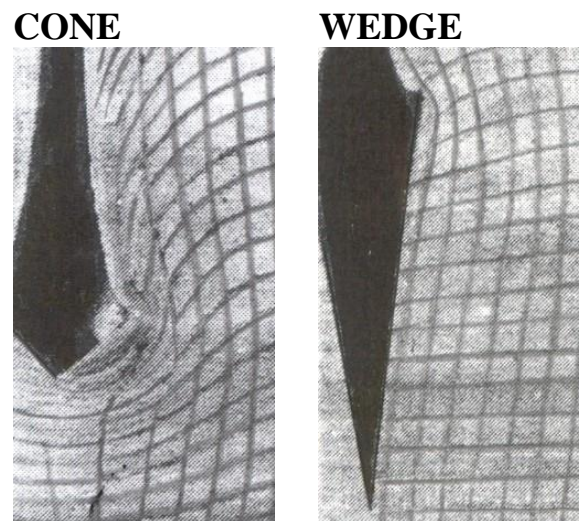

Fig. 46. Deformed grids by Baligh & Scott (1975)

14.3 ARCHING AND SENSITIVITY TO σ_h

Hughes & Robertson (1985) analyzed the horizontal stresses against the CPT sleeve in sands. They showed that at the level of the conical tip σ_h reaches very high values, while, behind the tip, σ_h undergoes an enormous stress reduction.

The penetration of the cone creates an annular zone of high residual stresses, at some distance from the sleeve. The resulting stiff annulus of precompressed sand is a *screen limiting σ_h at interface*, while the enormous unloading *makes undetermined σ_h* . This mechanism may be viewed as a form of an arching phenomenon.

A "plane" tip (DMT width/thickness ratio ≈ 6) should largely reduce arching and improve the possibility of sensing σ_h . Also the stress reduction after the wedge is considerably smaller due to the streamlined shape in the transition zone.

14.4 COMPLEXITY OF THE THEORETICAL MODELS

The DMT is more difficult to model than axisymmetric tips for at least two reasons:

- 1) The penetration of the DMT blade is a truly three-dimensional problem, in contrast with the two-dimensional nature of penetration of axisymmetric tips
- 2) The DMT is made of two stages:
 - Stage 1. Insertion.
 - Stage 2. Expansion. Moreover expansion is not the continuation of Stage 1.

A consequence of 1) and 2) is that theoretical solutions have been developed so far only for the first stage (insertion). Solutions have been worked out by Huang (1989), Whittle & Aubeny (1992), Yu et al. (1992), Finno (1993).

15. CROSS RELATIONS WITH RESULTS FROM OTHER IN SITU TESTS

15.1 RELATIONS DMT/PMT

Some information exists about relations between DMT and pressuremeter (PMT) results. Cross relations could help DMT users to apply the design methods developed for PMT.

Preliminary indications, in clays, suggest:

$$p_0/p_L \approx 0.8, p_1/p_L \approx 1.2 \quad (32)$$

(Schmertmann 1987)

$$p_1/p_L \approx 1.25, E_{PMT} \approx 0.4 E_D \quad (33)$$

(Kalteziotis et al. 1991)

where p_L = limit pressure from PMT.

Ortigo et al. (1996) investigated the Brasilia porous clay by Menard PMT, Plate Loading Tests (PLT) and DMT. As Kalteziotis, they found that

E_{PMT} was less than half E_D and also E_{PLT} . They explained such low PMT moduli with disturbance in the pressuremeter boring. After careful correction of the PMT field curve, E_{PMT} were similar to E_D and E_{PLT} .

Similar ratios (about 1/2) between PMT moduli and DMT moduli are quoted by Brown & Vinson (1998).

Dumas (1992) reports good agreement between settlements calculated with PMT and with DMT.

Contributions on DMT/PMT have also been presented by Lutenegger (1988), Sawada & Sugawara (1995), Schnaid et al. (2000).

15.2 RELATIONS DMT/CPT

As previously mentioned (Section 11.1.2.2), existing data suggest, in sand, the following broad cross relations:

$$M_{DMT}/q_c = 5-10 \quad \text{in NC sands} \quad (34)$$

$$M_{DMT}/q_c = 12-24 \quad \text{in OC sands} \quad (35)$$

15.3 RELATIONS DMT/SPT

According to Schmertmann (1988), the estimation of N_{SPT} from DMT would be "a gross misuse of the DMT data ... any such correlation depends on soil type and is probably site specific and perhaps also rig specific".

As a broad indication, Schmertmann (1988) cites the following relation, based on data from a number of US sites:

$$N_{SPT} = M_{DMT} \text{ (MPa)} / 3 \quad (36)$$

Tanaka & Tanaka (1998) based on data from three sandy sites (Tokyo and Niigata areas) indicate:

$$N_{SPT} = E_D \text{ (MPa)} / 2.5 \quad (37)$$

Blowcount SPT vs DMT

A limited number of parallel data, obtained in cases where the DMT was driven with the SPT equipment in gravels and silts, indicated very similar values of N_{SPT} and N_{DMT} (number of blows per 30 cm blade penetration).

SUMMARY

The Flat Dilatometer Test (DMT) is a push-in type in situ test quick, simple, economical, highly reproducible.

It is executable with a variety of field equipment.

It provides estimates of various design parameters/information (M , c_u , soil stratigraphy, deposit history).

One of the most fitting application is investigating the in situ soil compressibility for settlements prediction.

Interpretations and applications described by various Authors include:

- Compaction control
- Sensing the effects of pile installations (increase/decrease of D_r and σ_h)
- Liquefiability of sands
- Verify if a slope contains slip surfaces
- Axially loaded piles in cohesive soils
- Laterally loaded piles
- Pavement subgrade compaction control
- Coefficient of consolidation and permeability of clays
- Phreatic level in sands
- Help in selecting FEM input parameters.

REFERENCES

- ASTM Subcommittee D 18.02.10 - Schmertmann, J.H., Chairman (1986). "Suggested Method for Performing the Flat Dilatometer Test". ASTM Geotechnical Testing Journal, Vol. 9, No. 2, June, 93-101.
- ASTM D6635-01 (2001). "Standard Test Method for Performing the Flat Plate Dilatometer". Book of Standards Vol. 04.09.
- Aversa, S. (1997). "Experimental aspects and modeling in design of retaining walls and excavations" (in Italian). Proc. IV Nat. Conf. of the Geotechn. National Research Council Group, Perugia, Oct., Vol. II, 121-207.
- Baldi, G., Bellotti, R., Ghionna, V. & Jamiolkowski, M. (1988). "Stiffness of sands from CPT, SPT and DMT - A critical review". ICE Proc. Conf. Penetration Testing in the UK, Univ. of Birmingham, July, Paper No. 42, 299-305.
- Baldi, G., Bellotti, R., Ghionna, V., Jamiolkowski, M. & Lo Presti, D.C.F. (1989). "Modulus of Sands from CPT's and DMT's". Proc. XII ICSMFE, Rio de Janeiro, Vol. 1, 165-170.
- Baldi, G., Bellotti, R., Ghionna, V., Jamiolkowski, M., Marchetti, S. & Pasqualini, E. (1986). "Flat Dilatometer Tests in Calibration Chambers". Proc. In Situ '86, ASCE Spec. Conf. on "Use of In Situ Tests in Geotechn. Engineering", Virginia Tech, Blacksburg, VA, June, ASCE Geotechn. Special Publ. No. 6, 431-446.
- Baligh, M.M. (1985). "Strain path method". ASCE Jnl GE, Vol. 111, No. GT9, 1108-1136.
- Baligh, M.M. & Scott, R.F. (1975). "Quasi Static Deep Penetration in Clays". ASCE Jnl GE, Vol. 101, No. GT11, 1119-1133.
- Benoit, J. (1989). Personal communication to S. Marchetti.
- Boghrat, A. (1987). "Dilatometer Testing in Highly Overconsolidated Soils". Technical Note, ASCE Journal of Geotechn. Engineering, Vol. 113, No. 5, May, 516.
- Borden, R.H., Aziz, C.N., Lowder, W.M. & Khosla, N.P. (1986). "Evaluation of Pavement Subgrade Support Characteristics by Dilatometer Test". Proc. 64th Annual Meeting of the Transportation Res. Board, June, TR Record 1022.
- Brown, D.A. & Vinson, J. (1998). "Comparison of strength and stiffness parameters for a Piedmont residual soil". Proc. First Int. Conf. on Site Characterization ISC '98, Atlanta, GA, Apr., Vol. 2, 1229-1234.
- Burghignoli, A., Cavallera, L., Chieppa, V., Jamiolkowski, M., Mancuso, C., Marchetti, S., Pane, V., Paoliani, P., Silvestri, F., Vinale, F. & Vittori, E. (1991). "Geotechnical characterization of Fucino clay". Proc. X ECSMFE, Florence, Vol. 1, 27-40.
- Burland, J.B., Broms, B.B. & De Mello, V.F.B. (1977). "Behavior of foundations and structures". Proc. IX ICSMFE, Tokyo, Vol. 2, 495-546.
- Campanella, R.G. & Robertson, P.K. (1991). "Use and Interpretation of a Research Dilatometer". Canad. Geotechn. Journal, Vol. 28, 113-126.
- Campanella, R.G., Robertson, P.K., Gillespie, D.G. & Grieg, J. (1985). "Recent Developments in In-Situ Testing of Soils". Proc. XI ICSMFE, S. Francisco, Vol. 2, 849-854.
- Carter, J.P., Randolph, M.F. & Wroth, C.P. (1979). "Stress and pore pressure changes in clay during and after the expansion of a cylindrical cavity". Int. Jnl Numer. Anal. Methods Geomech., Vol. 3, 305-322.
- Davidson, J. & Boghrat, A. (1983). "Displacements and Strains around Probes in Sand". Proc. ASCE Spec. Conf. on "Geotechnical Practice in Offshore Engineering", Austin, TX, Apr., 181-203.
- De Cock, F., Van Impe, W.F. & Peiffer, H. (1993). "Atlas screw piles and tube screw piles in stiff tertiary clays". Proc. BAP II, Ghent, 359-367.
- Didaskalou, G. (1999). "Comparison between observed and DMT predicted settlements of the Hyatt Regency Hotel shallow foundation on a compressible silt in Thessaloniki". Personal communication to S. Marchetti.
- Dumas, J.C. (1992). "Comparisons of settlements predicted by PMT and DMT in a silty-sandy soil in Quebec". Personal communication to S. Marchetti.
- Durgunoglu, H.T. & Mitchell, J.K. (1975). "Static Penetration Resistance of Soils, I - Analysis, II - Evaluation of the Theory and Implications for Practice". ASCE Spec. Conf. on "In Situ Measurement of Soil Properties", Raleigh, NC, Vol. 1.
- Eurocode 7 (1997). Geotechnical design - Part 3: Design assisted by field testing, Section 9: Flat dilatometer test (DMT). Final Draft, ENV 1997-3, Apr., 66-73. CEN - European Committee For Standardization.
- Failmezger, R.A., Rom, D. & Ziegler, S.B. (1999). "Behavioral Characteristics of Residual Soils. SPT? - A Better Approach to Site Characterization of Residual Soils using other In-Situ Tests". ASCE Geot. Special Pub. No. 92, Edelen, Bill, ed., ASCE, Reston, VA, 158-175.
- Finno, R.J. (1993). "Analytical Interpretation of Dilatometer Penetration Through Saturated Cohesive Soils". Geotéchnique, 43, No. 2, 241-254.
- Fretti, C., Lo Presti, D. & Salgado, R. (1992). "The Research Dilatometer: In Situ and Calibration Chamber Test Results". Riv. Italiana di Geotecnica, 26, No. 4, 237-243.
- Gravesen, S. (1960). "Elastic Semi-Infinite Medium Bounded by a Rigid Wall with a Circular Hole". Laboratoriet for Bygningsteknik, Danmarks Tekniske Højskole, Meddelelse No. 10, Copenhagen.
- Hamza, M. & Richards, D.P. (1995). "Correlations of DMT, CPT and SPT in Nile Basin Sediment". Proc. XI Afr. Conf. SMFE, Cairo, 437-446.
- Hayes, J.A. (1990). "The Marchetti Dilatometer and Compressibility". Seminar on "In Situ Testing and Monitoring", Southern Ont. Section of Canad. Geot. Society, Sept., 21 pp.
- Hryciw, R.D. (1990). "Small-Strain-Shear Modulus of Soil by Dilatometer". ASCE Jnl GE, Vol. 116, No. 11, Nov., 1700-1716.
- Huang, A.B. (1989). "Strain-Path Analyses for Arbitrary Three Dimensional Penetrometers". Int. Jnl for Num. and Analyt.

- Methods in Geomechanics, Vol. 13, 561-564.
- Huang, A.B., Bunting, R.D. & Carney, T.C. (1991). "Piezoblade Tests in a Clay Calibration Chamber". Proc. ISOCCT-1, Clarkson Univ., Potsdam, NY, June.
- Hughes, J.M.O. & Robertson, P.K. (1985). "Full displacement pressuremeter testing in sand". *Canad. Geot. Jnl*, Vol. 22, No. 3, Aug., 298-307.
- Iwasaki, K., Tsuchiya, H., Sakai, Y. & Yamamoto, Y. (1991). "Applicability of the Marchetti Dilatometer Test to Soft Ground in Japan". Proc. GEOCOAST '91, Yokohama, Sept., 1/6.
- Jamiolkowski, M. (1995). "Opening address". Proc. Int. Symp. on Cone Penetration Testing CPT '95, Swedish Geot. Soc., Linköping, Vol. 3, 7-15.
- Jamiolkowski, M., Ghionna, V., Lancellotta, R. & Pasqualini, E. (1988). "New Correlations of Penetration Tests for Design Practice". Proc. ISOPT-1, Orlando, FL, Vol. 1, 263-296.
- Jendebly, L. (1992). "Deep Compaction by Vibrowing". Proc. Nordic Geotechnical Meeting NGM-92, Vol. 1, 19-24.
- Kaggwa, W.S., Jaksa, M.B. & Jha, R.K. (1995). "Development of automated dilatometer and comparison with cone penetration test at the Univ. of Adelaide, Australia". Proc. Int. Conf. on Advances in Site Investig. Practice, ICE, London, Mar.
- Kalteziotis, N.A., Pachakis, M.D. & Zervogiannis, H.S. (1991). "Applications of the Flat Dilatometer Test (DMT) in Cohesive Soils". Proc. X ECSMFE, Florence, Vol. 1, 125-128.
- Kamey, T. & Iwasaki, K. (1995). "Evaluation of undrained shear strength of cohesive soils using a Flat Dilatometer". *Soils and Foundations*, Vol. 35, No. 2, June, 111-116.
- Kulhawy, F. & Mayne, P. (1990). "Manual on Estimating Soil Properties for Foundation Design". Electric Power Research Institute, Cornell Univ., Ithaca, NY, Report No. EL-6800, 250 pp.
- Lacasse, S. (1986). "In Situ Site Investigation Techniques and Interpretation for Offshore Practice". Norwegian Geotechnical Inst., Report 40019-28, Sept.
- Lacasse, S. & Lunne, T. (1986). "Dilatometer Tests in Sand". Proc. In Situ '86, ASCE Spec. Conf. on "Use of In Situ Tests in Geotechn. Engineering", Virginia Tech, Blacksburg, VA, June, ASCE Geotechn. Special Publ. No. 6, 686-699.
- Lacasse, S. & Lunne, T. (1988). "Calibration of Dilatometer Correlations". Proc. ISOPT-1, Orlando, FL, Vol. 1, 539-548.
- Leonards, G.A. & Frost, J.D. (1988). "Settlements of Shallow Foundations on Granular Soils". *ASCE Jnl GE*, Vol. 114, No. 7, July, 791-809.
- Lunne, T., Lacasse, S. & Rad, N.S. (1989). "State of the Art Report on In Situ Testing of Soils". Proc. XII ICSMFE, Rio de Janeiro, Vol. 4, 2339-2403.
- Lutenegger, A.J. (1988). "Current status of the Marchetti dilatometer test". Special Lecture, Proc. ISOPT-1, Orlando, FL, Vol. 1, 137-155.
- Lutenegger, A.J. & Kabir, M.G. (1988). "Dilatometer C-reading to help determine stratigraphy". Proc. ISOPT-1, Orlando, FL, Vol. 1, 549-554.
- Marchetti, S. (1980). "In Situ Tests by Flat Dilatometer". *ASCE Jnl GED*, Vol. 106, No. GT3, Mar., 299-321.
- Marchetti, S. (1982). "Detection of liquefiable sand layers by means of quasi static penetration tests". Proc. 2nd European Symp. on Penetration Testing, Amsterdam, May, Vol. 2, 689-695.
- Marchetti, S. (1985). "On the Field Determination of K_0 in Sand". Discussion Session No. 2A, Proc. XI ICSMFE, San Francisco, Vol. 5, 2667-2673.
- Marchetti, S. (1994). "An example of use of DMT as a help for evaluating compaction of subgrade and underlying embankment". Internal Techn. Note, Draft.
- Marchetti, S. (1997). "The Flat Dilatometer: Design Applications". Proc. Third International Geotechnical Engineering Conference, Keynote lecture, Cairo University, Jan., 421-448.
- Marchetti, S. (1999). "On the calibration of the DMT membrane". L'Aquila Univ., Unpublished report, Mar.
- Marchetti, S. & Crapps, D.K. (1981). "Flat Dilatometer Manual". Internal Report of G.P.E. Inc.
- Marchetti, S. & Totani, G. (1989). " C_h Evaluations from DMTA Dissipation Curves". Proc. XII ICSMFE, Rio de Janeiro, Vol. 1, 281-286.
- Marchetti, S., Totani, G., Calabrese, M. & Monaco, P. (1991). "P-y curves from DMT data for piles driven in clay". Proc. 4th Int. Conf. on Piling and Deep Foundations, DFI, Stresa, Vol. 1, 263-272.
- Marchetti, S., Totani, G., Campanella, R.G., Robertson, P.K. & Taddei, B. (1986). "The DMT- σ_{hc} Method for Piles Driven in Clay". Proc. In Situ '86, ASCE Spec. Conf. on "Use of In Situ Tests in Geotechn. Engineering", Virginia Tech, Blacksburg, VA, June, ASCE Geotechn. Special Publ. No. 6, 765-779.
- Massarsch, K.R. (1994). "Settlement Analysis of Compacted Granular Fill". Proc. XIII ICSMFE, New Delhi, Vol. 1, 325-328.
- Matlock, H. (1970). "Correlation for Design of Laterally Loaded Piles in Soft Clay". Proc. II Offshore Technical Conf., Houston, TX, Vol. 1, 577-594.
- Mayne, P.W. & Martin, G.K. (1998). "Seismic flat dilatometer test in Piedmont residual soils". Proc. First Int. Conf. on Site Characterization ISC '98, Atlanta, GA, Apr., Vol. 2, 837-843.
- Mesri, G., Feng, T.W. & Shahien, M. (1999). "Coefficient of Consolidation by Inflection Point Method". *ASCE Jnl GGE*, Vol. 125, No. 8, Aug., 716-718.
- Nash, D.F.Y., Powell, J.J.M. & Lloyd, I.M. (1992). "Initial investigations of the soft clay test site at Bothkennar". *Geotéchnique*, 42, No. 2, 163-181.
- Ortigao, J.A.R., Cunha, R.P. & Alves, L.S. (1996). "In situ tests in Brasilia porous clay". *Canad. Geot. Jnl*, Vol. 33, No. 1, Feb., 189-198.
- Pasqualini, E. & Rosi, C. (1993). "Experiences from a vibroflotation treatment" (in Italian). Proc. Annual Meeting of the Geotechn. National Research Council Group, Rome, Nov., 237-240.
- Peiffer, H. (1997). "Evaluation and automatisisation of the dilatometer test and interpretation towards the shaft bearing capacity of piles". Doctoral Thesis, Ghent University.
- Peiffer, H. & Van Impe, W.F. (1993). "Evaluation of pile performance based on soil stress measurements - Field test program". Proc. BAP II, Ghent, 385-389.
- Peiffer, H., Van Impe, W.F., Cortvrindt, G. & Bottiau, M. (1993). "Evaluation of the influence of pile execution parameters on the soil condition around the pile shaft of a PCS-pile". Proc. BAP II, Ghent, 217-220.
- Peiffer, H., Van Impe, W.F., Cortvrindt, G. & Bottiau, M. (1994). "DMT Measurements around PCS-Piles in Belgium". Proc. XIII ICSMFE, New Delhi, Vol. 2, 469-472.
- Pelnik, T.W., Fromme, C.L., Gibbons, Y.R. & Failmezger, R.A. (1999). "Foundation Design Applications of CPTU and DMT Tests in Atlantic Coastal Plain Virginia". Transp. Res. Board, 78th Annual Meeting, Jan., Washington, D.C.
- Powell, J.J.M., Lunne, T. & Frank, R. (2001 a). "Semi-

- Empirical Design Procedures for axial pile capacity in clays". Proc. XV ICSMGE, Istanbul, Aug., Balkema.
- Powell, J.J.M., Shields, C.H., Dupla, J.C. & Mokkelbost, K.H. (2001 b). "A new DMT method for the design of axially loaded driven piles in clay soils". Submitted for publication.
- Powell, J.J.M. & Uglow, I.M. (1988). "The Interpretation of the Marchetti Dilatometer Test in UK Clays". ICE Proc. Conf. Penetration Testing in the UK, Univ. of Birmingham, July, Paper No. 34, 269-273.
- Reyna, F. & Chameau, J.L. (1991). "Dilatometer Based Liquefaction Potential of Sites in the Imperial Valley". Proc. 2nd Int. Conf. on Recent Advances in Geot. Earthquake Engrg. and Soil Dyn., St. Louis, May.
- Robertson, P.K. & Campanella, R.G. (1986). "Estimating Liquefaction Potential of Sands Using the Flat Plate Dilatometer". ASTM Geotechn. Testing Journal, Mar., 38-40.
- Robertson, P.K., Campanella, R.G., Gillespie, D. & By, T. (1988). "Excess Pore Pressures and the Flat Dilatometer Test". Proc. ISOPT-1, Orlando, FL, Vol. 1, 567-576.
- Robertson, P.K., Davies, M.P. & Campanella, R.G. (1987). "Design of Laterally Loaded Driven Piles Using the Flat Dilatometer". Geot. Testing Jnl, Vol. 12, No. 1, Mar., 30-38.
- Ruesta, F. & Townsend, F.C. (1997). "Evaluation of Laterally Loaded Pile Group at Roosevelt Bridge". Jnl ASCE GGE, 123, 12, Dec., 1153-1161.
- Sawada, S. & Sugawara, N. (1995). "Evaluation of densification of loose sand by SBP and DMT". Proc. 4th Int. Symp. on Pressuremeter, May, 101-107.
- Schmertmann, J.H. (1982). "A method for determining the friction angle in sands from the Marchetti dilatometer test (DMT)". Proc. 2nd European Symp. on Penetration Testing, ESOPT-II, Amsterdam, Vol. 2, 853-861.
- Schmertmann, J.H. (1983). "Revised Procedure for Calculating K_0 and OCR from DMT's with $I_D > 1.2$ and which Incorporates the Penetration Measurement to Permit Calculating the Plane Strain Friction Angle". DMT Digest No. 1. GPE Inc., Gainesville, FL.
- Schmertmann, J.H. (1986). "Dilatometer to compute Foundation Settlement". Proc. In Situ '86, ASCE Spec. Conf. on "Use of In Situ Tests in Geotechn. Engineering", Virginia Tech, Blacksburg, VA, June, ASCE Geotechn. Special Publ. No. 6, 303-321.
- Schmertmann, J.H., Baker, W., Gupta, R. & Kessler, K. (1986). "CPT/DMT Quality Control of Ground Modification at a Power Plant". Proc. In Situ '86, ASCE Spec. Conf. on "Use of In Situ Tests in Geotechn. Engineering", Virginia Tech, Blacksburg, VA, June, ASCE Geotechn. Special Publ. No. 6, 985-1001.
- Schmertmann, J.H. (1987). "Some interrelationship with p_0 in clays". DMT Digest No. 9, Item 9A, Schmertmann Ed., May.
- Schmertmann, J.H. (1988). "Guidelines for Using the CPT, CPTU and Marchetti DMT for Geotechnical Design". Rept. No. FHWA-PA-87-022+84-24 to PennDOT, Office of Research and Special Studies, Harrisburg, PA, in 4 volumes with the 3 below concerning primarily the DMT: Vol. I - Summary (78 pp.); Vol. III - DMT Test Methods and Data Reduction (183 pp.); Vol. IV - DMT Design Method and Examples (135 pp.).
- Schmertmann, J.H. (1991). "Pressure Dissipation Tests. A-B-C vs A_2 vs A". DMT Digest No. 12, Section 12C, Schmertmann Ed., Dec.
- Schnaid, F., Ortigao, J.A.R., Mantaras, F.M, Cunha, R.P. & MacGregor, I. (2000). "Analysis of self-boring pressuremeter (SBPM) and Marchetti dilatometer (DMT) tests in granite saprolites". Canad. Geot. Jnl, Vol. 37, 4, Aug., 796-810.
- Skiles, D.L. & Townsend, F.C. (1994). "Predicting Shallow Foundation Settlement in Sands from DMT". Proc. Settlement '94 ASCE Spec. Conf., Texas A&M Univ., Geot. Spec. Publ. No. 40, Vol. 1, 132-142.
- Steiner, W. (1994). "Settlement Behavior of an Avalanche Protection Gallery Founded on Loose Sandy Silt". Proc. Settlement '94 ASCE Spec. Conf., Texas A&M Univ., Geot. Spec. Publ. No. 40, Vol. 1, 207-221.
- Steiner, W., Metzger, R. & Marr, W.A. (1992). "An Embankment on Soft Clay with an Adjacent Cut". Proc. ASCE Conf. on Stability and Performance of Slopes and Embankments II, Berkeley, CA, 705-720.
- Sully, J.P. & Campanella, R.G. (1989). "Correlation of Maximum Shear Modulus with DMT Test Results in Sand". Proc. Proc. XII ICSMFE, Rio de Janeiro, Vol. 1, 339-343.
- Tanaka, H. & Tanaka, M. (1998). "Characterization of Sandy Soils using CPT and DMT". Soils and Foundations, Japanese Geot. Soc., Vol. 38, No. 3, 55-65.
- Terzaghi, K. & Peck, R.B. (1967). "Soil Mechanics in Engineering Practice". John Wiley & Sons, NY.
- Totani, G., Calabrese, M., Marchetti, S. & Monaco, P. (1997). "Use of in situ flat dilatometer (DMT) for ground characterization in the stability analysis of slopes". Proc. XIV ICSMFE, Hamburg, Vol. 1, 607-610.
- Totani, G., Calabrese, M. & Monaco, P. (1998). "In situ determination of c_h by flat dilatometer (DMT)". Proc. First Int. Conf. on Site Characterization ISC '98, Atlanta, GA, Apr., Vol. 2, 883-888.
- Totani, G., Marchetti, S., Calabrese, M. & Monaco, P. (1994). "Field studies of an instrumented full-scale pile driven in clay". Proc. XIII ICSMFE, New Delhi, Vol. 2, 695-698.
- US DOT - Briaud, J.L. & Miran, J. (1992). "The Flat Dilatometer Test". Departm. of Transportation - Fed. Highway Administr., Washington, D.C., Publ. No. FHWA-SA-91-044, Feb., 102 pp.
- Van Impe, W.F., De Cock, F., Massarsch, R. & Menge', P. (1994). "Recent Experiences and Developments of the Resonant Vibrocompaction Technique". Proc. XIII ICSMFE, New Delhi, Vol. 3, 1151-1156.
- Whittle, A.J. & Aubeny, C.P. (1992). "The effects of installation disturbance on interpretation of in situ tests in clay". Proc. Wroth Memorial Symp. Predictive Soil Mechanics, Oxford, July, 742-767.
- Woodward, M.B. & McIntosh, K.A. (1993). "Case history: Shallow Foundation Settlement Prediction Using the Marchetti Dilatometer". ASCE Annual Florida Sec. Meeting - Abstract & Conclusions.
- Yu, H.S., Carter, J.P. & Booker, J.R. (1992). "Analysis of the Dilatometer Test in Undrained Clay". Proc. Wroth Memorial Symp. Predictive Soil Mechanics, Oxford, July, 783-795.